

EXECUTIVE Precisa 360 ES

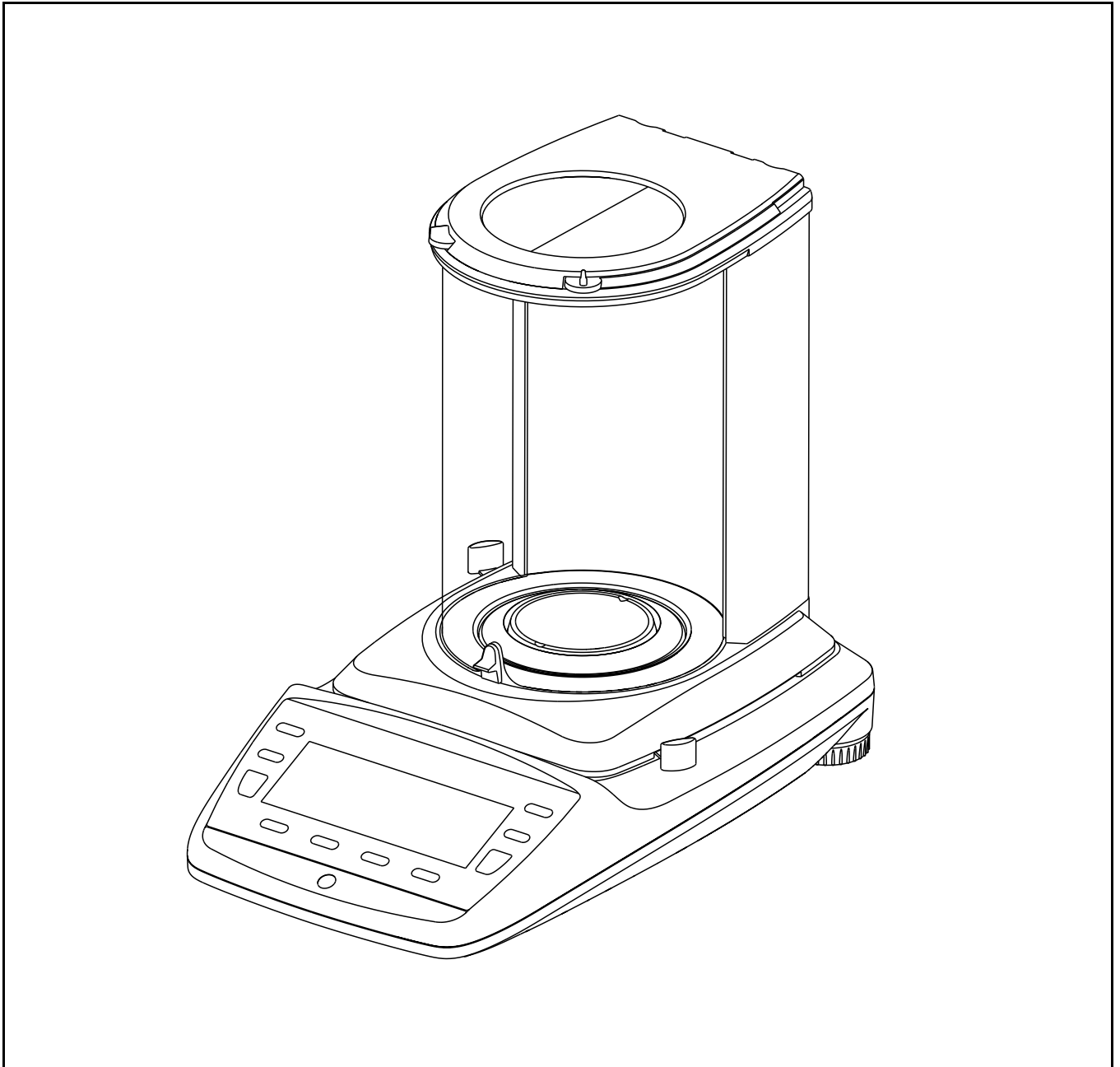

Operating Instructions

Identification

Customer service

Precisa Gravimetrics AG
Moosmattstrasse 32
CH-8953 Dietikon
Tel. + 41-44-744 28 28
Fax. + 41-44-744 28 38
email service@precisa.ch

<http://www.precisa.com>

Refer to our website for information about local customer service centers and details of their addresses.

Copyright

These operating instructions are protected by copyright. All rights reserved. No part of the operating instructions may be reproduced, processed, duplicated or published in any form by photocopying, microfilming, reprinting or other process, in particular electronic means, without the written agreement of Precisa Gravimetrics AG.

© Precisa Gravimetrics AG, 8953 Dietikon, Switzerland, 2012

1 Overview

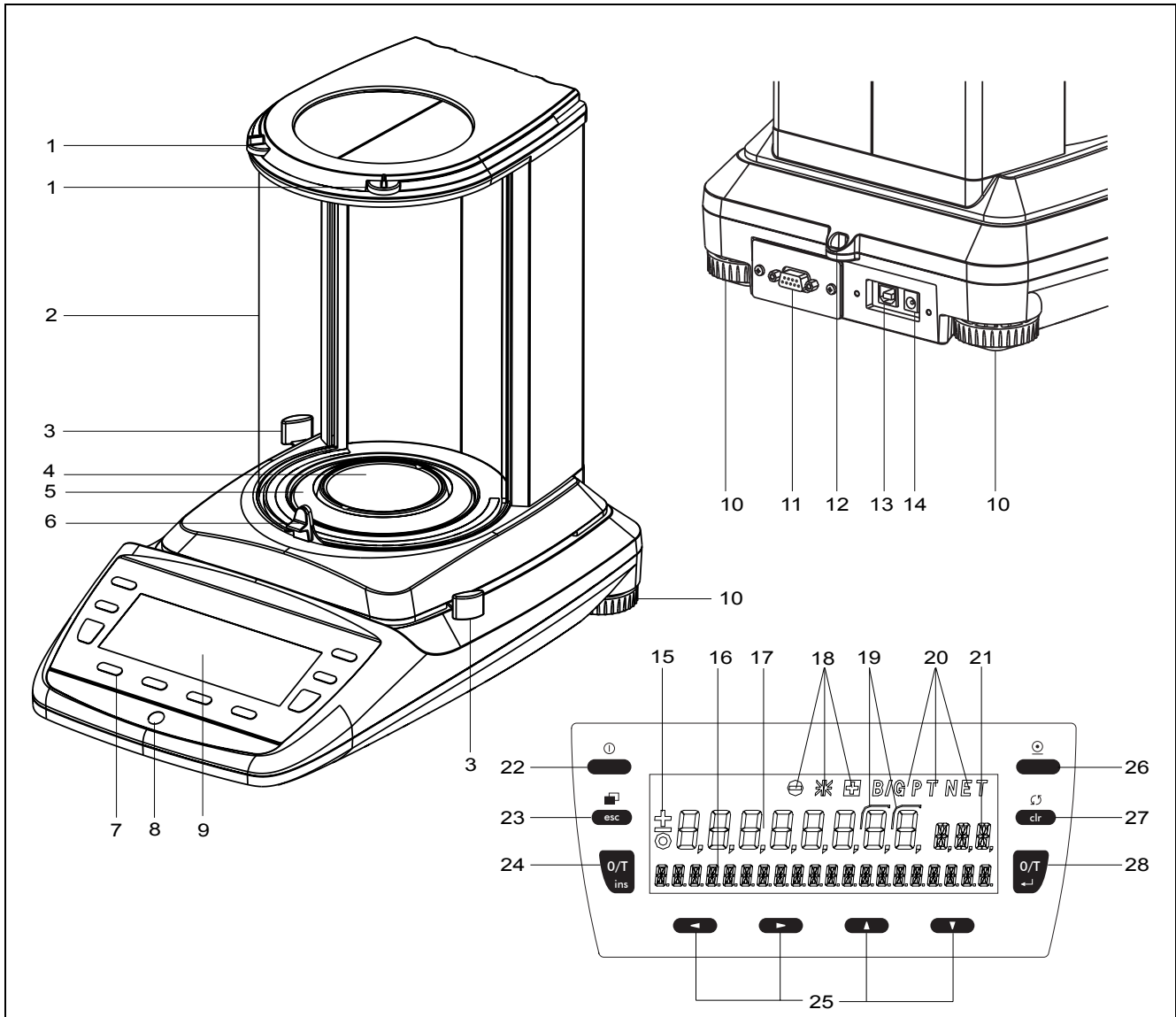

No.	Description	Section / Page	No.	Description	Section / Page
1	Top draft shield opening		15	Prefix display	9.9 / 14
2	Draft shield	2 / 3	16	Info display	
3	Side draft shield opening		17	Measurement display	
4	Weighing pan	2 / 3	18	Weight check	13 / 34
5	Protective ring	2 / 3	19	Brackets to mark not approved digits	
6	Switch for draft shield opening mode		20	Symbol display	
7	10-key control panel	10.1 / 15	21	Unit display	10.3.2 / 17
8	Levelling bubble	9.6 / 13	22	ON / OFF key	9.10 / 14
9	Display		23	Menu / ESC key	10.5.1 / 24
10	Adjustable feet	9.6 / 13	24	Tare / Insert key	10.4.1 / 23
11	Serial interface, DB9 Female	21.1 / 66	25	Cursor keys	10.1 / 15
12	Mechanical anti-theft protection		26	Print key	10.4.2 / 23
13	USB device connector for connection to PC	21.1 / 66	27	Change / Clear key	10.4.3 / 24
14	Connecting socket for power adapter	9.5 / 13	28	Tare / Enter key	10.4.1 / 23

2 Inspection and assembly

Inspect delivery for complete supply immediately on unpacking all components.

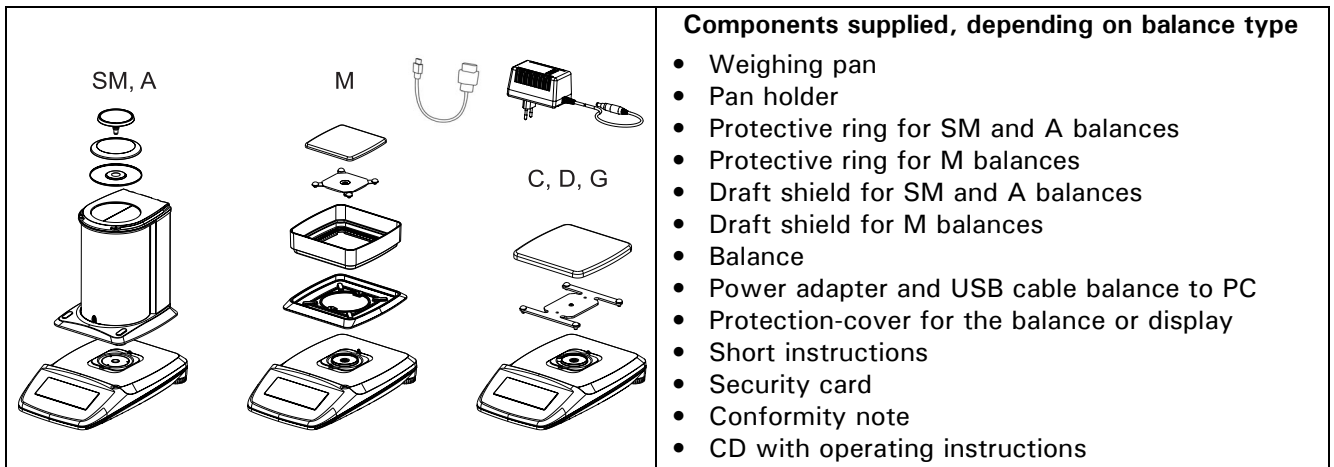

The balance is delivered in partly dismantled condition. Assemble the individual components in the following sequence:

- Install the draft shield as well or the protective ring with the two screws supplied
- Place the weighing pan in position
- Insert the power adaptor cable plug into the socket at the rear of the balance.

! NOTE

A screwdriver is required for assembly.

All parts must fit together easily. Do not apply force. Customer Service will be pleased to help you with any problems.

■ 3 Firmware and serial number

3 Firmware and serial number

After a reconnection of the balance to the mains and switching on for the first time the serial number as well as the firmware will be showed in the upper display.

Display	Remark
4700051	Serial number: 4700051
01,00 P04 B00	Firmware: B01-0100.P04
B00: Hardwarecode 01,00: Version P04: Release	

4 Data and parameters

The balances are divided into five main-groups SM, A, C, D, G and M. The letter in the name corresponds to the design specification (e.g. SM = semi micro, A = analytical balance, M = Milligramme balance) the number before it corresponding in each case to the maximum allowable load (in grammes).

The allowable weighing range, the calibration value and the readability of the balance are printed on the type plate and sales plate stuck to the casing and are therefore not presented here.

The following applies to all balances:

- **Mains connection**
 - 115 - 230V (+ 15/-20%); 50 - 60Hz
- **Power consumption**
 - without peripheral appliances 18.0 VA
- **RS232/V24 Interface**
- **USB device Interface**
- **Allowable ambient conditions**
 - Temperature: 5°C ... 40°C
 - Relative humidity: 25%... 85%, non-condensing
- If you have any questions on the technical data or require detailed technical information on your balance, please contact your Technical Representative.

5 Below-balance weighing

Objects which, because of their size or shape, cannot be put on the scale, can be weighed by means of below-balance weighing.

Proceed as follows:

- Turn off the balance.
- Remove the weighing pan and the pan holder then turn the balance up side down.
- Push the metal-cover (1) on the floor of the balance to one side.
- Hang a small hook (available as an accessory, see chapter 6 "Accessories") into the aperture (3) of the now visible metal casting (2).
- Place the balance over an opening.
- Replace the pan holder and the weighing pan.
- Level the balance (see chapter 3.6 "Levelling")
- Switch on the balance.
- Hang the object to be weighed on the hook and carry out the weighing.

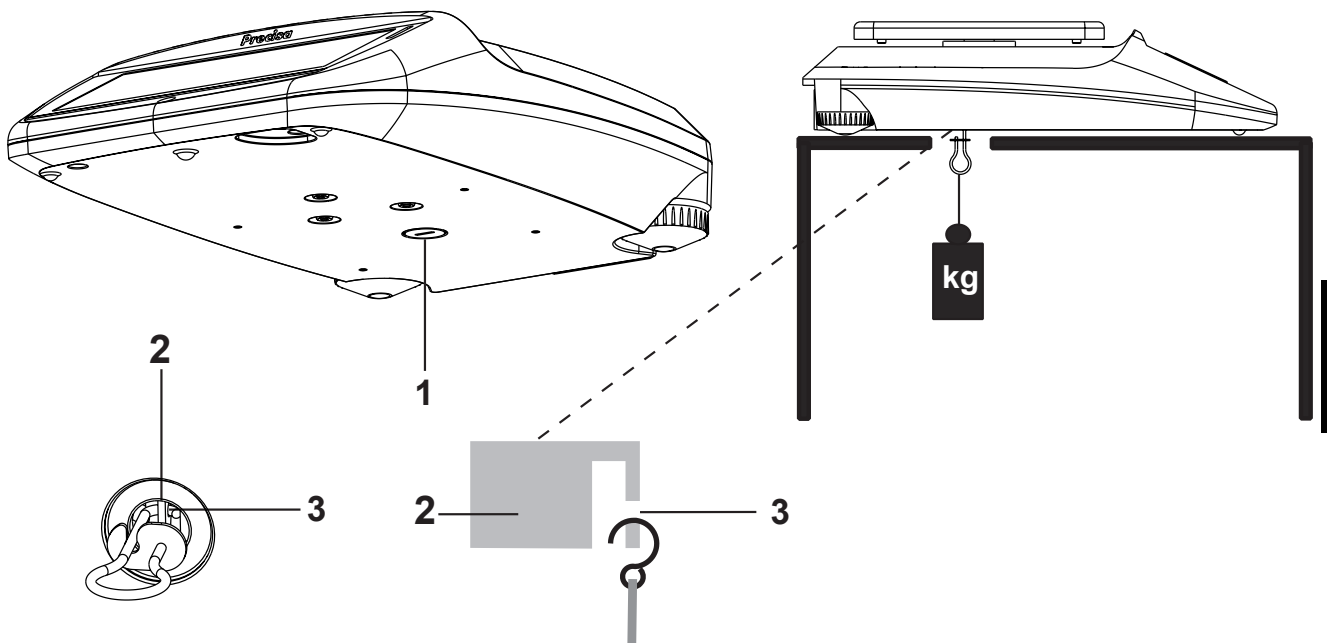

English

⚠ CAUTION

Take care that the hooks used for the below-balance weighing are stable enough to hold the goods which you wish to weigh.

ⓘ NOTE

Take care that no dirt or moisture can get into the balance with the weighing pan removed. After completing the below-balance weighing, the opening in the floor of the balance must be closed again (dust protection).

■ 6 Accessories

6 Accessories

Accessorie	Article number
Draft shield 360 automatic for 0.01mg and 0.1mg balances, height 260mm	350-8657
Draft shield 360 automatic for 0.01mg and 0.1mg balances, height 180mm	350-8658
Draft shield 360 manual for 0.01mg and 0.1mg balances, height 180mm	350-8660
Draft shield 320 XB for 0.01mg and 0.1mg balances, height 260mm requires adapter for 1mg, 0.01g, 0.1g and 1g balances*	350-8519
Draft shield 320 XB for 0.01mg and 0.1mg balances, height 180mm requires adapter for 1mg, 0.01g, 0.1g and 1g balances*	350-8518
*adapter for 1mg, 0.01g, 0.1g and 1g balances	350-7402
Draft shield mg, glass with cover	320-8504
Density kit for 0.01mg and 0.1mg balances Container size Ø 75mm, height 100mm	350-8536
Density kit for solids only (w/o Glass body and Hook) for 0.01mg and 0.1mg balances Container size Ø 75mm, height 100mm	350-8537
Glass body 10ccm for density determination of liquids	350-7054
Downholder for samples with density < 1 g/cm ³	350-7194
Animal weighing bowl complete for 0.01g, 0.1 and 1g balances	350-8551
Diamond weighing pan	350-8322
Hook for weighing below the balance	350-8527
Dust cover 360 for the whole balance, set of 20 pieces (for 0.01mg and 0.1mg balances)	350-8663 (350-8676)
Data cable DB9 Male / DB9 Female (PC), 1.5m	350-8672
Data cable DB9 Male / DB25 Male (Printer), 1.5m	350-8673
Slide-in modules	Article number
Precisa BUS converter	350-8664

Additional SmartBox® Applications, Precisa BUS accessories, further special accessories and options on demand.

■ Contents

1	Overview	2	10.4.2	The print key	23
2	Inspection and assembly	3	10.4.3	The change key.....	24
3	Firmware and serial number	4	10.5	Application menu.....	24
4	Data and parameters	4	10.5.1	Activating the application menu	24
5	Below-balance weighing	5	10.5.2	Selecting an application program	25
6	Accessories	6	11	Application	26
7	Introduction	10	11.1	Units.....	26
7.1	Useful tips on the Operating Instructions	10	11.2	Count	26
7.2	Warranty card	10	11.3	Percent	27
7.3	Conformity	10	11.4	Calculator.....	28
8	Safety	11	11.5	Paper	29
8.1	Representations and symbols	11	11.6	Net-Total.....	29
8.2	Safety recommendations	11	11.7	Sum.....	30
9	Set up	12	11.8	Animal	31
9.1	Unpacking the balance	12	12	Statistics	32
9.2	Transport and shipping	12	13	Check-Weighing	34
9.3	Storage	12	14	Density ("DENSITY")	36
9.4	Choosing a suitable location.....	13	14.1	Explanatory notes on density determination	36
9.5	Connecting the balance to the mains..	13	14.1.1	Methods of determination.....	36
9.6	Levelling.....	13	14.1.2	Density index calculation	36
9.7	Calibration of the balance	13	14.2	Selecting the density determination	36
9.8	Dual Range and Floating Range balances	14	14.3	application.....	36
9.9	Standardized balance	14	14.4	Configuring the density determination	37
9.10	Switching on the balance	14	14.5	Starting and initializing the density program	37
9.11	Auto-Standby Mode.....	14	14.6	Density of a liquid "MODE LIQUID"	38
10	Operation.....	15	14.7	(with density kit 350-8515).....	38
10.1	Menu control operation principle	15	14.8	Density of a solid "MODE SOLID IN AIR"	39
10.1.1	Operating in the Weighing mode	15	14.8	Density of a porous solid	40
10.1.2	Operation in the programming mode ..	16	14.8	"MODE SOLID POROUS"	40
10.2	Setting the factory configuration	16	15	Density of a solid	41
10.3	Device configuration	16	15	Differential weighing	42
10.3.1	Activating the configuration menu	17	15.1	("DIFF.-WEIGHT").....	42
10.3.2	Selecting the weight unit.....	17	15.1	Explanatory notes on differential weighing	42
10.3.3	Print functions.....	18	15.2	42	
10.3.4	Calibration functions	18	15.2	Selecting the differential weighing	42
10.3.5	Weighing mode	19	15.3	application	42
10.3.6	Interface functions.....	20	15.3	Configuring the differential weighing ..	42
10.3.7	Date and time.	20	15.3.1	Overview.....	42
10.3.8	Anti-theft encoding	21	15.3.2	Units.....	43
10.3.9	Key tone	22	15.4	Working with differential weighing.....	44
10.3.10	Precisa BUS	22	15.4.1	Mode, measurement recording	45
10.3.11	Language function	22	15.4.2	Measurement	46
10.3.12	Backlight	22	15.4.3	Sample information.....	47
10.3.13	Automatic draft shield.....	22	15.4.4	Deleting samples, groups.....	48
10.4	Special operating keys.....	23	15.4.5	Statistics	48
10.4.1	The tare key	23			

7 Introduction

These balances are simple and functional to operate.

The versatile weighing programs allow you to use these balances not only for simple weighing procedures but also in a simple manner for carrying out various weighing applications such as, for example, percentage- or component counting weighings and document the measurements obtained accurately and unequivocally. Virtually all models can be delivered in weights and measures approved.

The most important basic production features of the Precisa balances include:



- Simple-to-use 10-key multifunction control panel
- Large LCD display with multi-line display
- Anti-theft encoding with four-figure numerical code
- 10 user profiles (MUM Multiuser Memory)
- ICM-Autocalibration (intelligent calibration mode)
- USB device interface for data transfer to PC
- RS232/V24 serial interface for data transfer to PC or printers
- ISO- and GLP-compliant reporting of results of measurements
- Capacity and residual tare display
- Various application programs:
Piece counting, Percentage weighing, Formulation, Animal weighing, Calculator, Check and reference weighing and lot others
- Statistics program
- Appliance for below-balance weighing

7.1 Useful tips on the Operating Instructions

You should read through these operating instructions in their entirety, so that you can make optimum use of the full potential and the diverse features of the balance in your daily work.

These operating instructions contain guidance in the form of pictograms and keyboard diagrams, which should help you find the required information:

- Key names are presented in quotation marks and are highlighted in semi-bold script: «**ON/OFF**» or «**↻**».
- When explaining the operating steps, the appropriate display for the current operating step is shown for clarity at the left alongside the list of operating steps:

Display	Key	Step
		<i>Press repeatedly, until the language currently activated is displayed.</i>

7.2 Warranty card

A warranty card, which was filled in by your dealer before handing over the balance, is enclosed with the instruction manual.

!	NOTE
Check that the warranty card is enclosed with these operating instructions and is completely filled out.	

7.3 Conformity



The balance has been manufactured and tested in accordance with the standards and recommendations set out in the enclosed certificate of conformity.

The power adaptor produced for the operation of the balance and intended exclusively for this application, complies with Electrical Protection Class II.

8 Safety

8.1 Representations and symbols

Important safety instructions are highlighted with the appropriate symbol:

 DANGER
Warning of a possible danger which can lead to death or to serious injuries.
 CAUTION
Warning of a possibly dangerous situation which can lead to less severe injuries or damage.
 NOTE
Tips and important rules on the correct operation of the balance.

8.2 Safety recommendations

- When using the balance in surroundings with increased safety requirements the corresponding regulations must be observed.
- The balance may only be used with the power adaptor supplied exclusively for use with this balance.
- Before plugging in the power adaptor, make sure that the operating voltage stated on the power adaptor agrees with the mains voltage. If not, please refer to the Customer Service.
- If the power adaptor or its cable is damaged, the balance must immediately be disconnected from the electricity supply (pull out the power adaptor). The balance may only be operated with a power adaptor in perfect condition.
- If there is any reason to believe that it is no longer possible to operate the balance without danger, the balance must immediately be unplugged from the electricity supply (pull out power adaptor) and secured against inadvertent operation.
- In carrying out maintenance work, it is essential to heed the recommendations in chapter 22.4 "Cleaning".
- The balance must not be operated in an area subject to explosion risks.
- Take care when weighing liquids that no liquid is spilt into the inside of the balance or into connections on the rear of the equipment or the power adaptor.
If liquid is spilt on the balance, the latter must immediately be unplugged from the mains electricity supply (pull out power adaptor).
The balance may only be operated after it has first been re-checked by a Service technician.
- The operating instructions must be read by each operator of the balance and must be available at the workplace at all times. The balance may only be used for the weighing of solid-materials and of liquids filled into secure containers and for animal weighing and density determinations. The maximum allowable load of the balance must never be exceeded, otherwise the balance may be damaged.
- When using the balance in combination with other appliances, the current regulations for the safe use of the relevant attachments and their application in accordance with instructions must always be observed.

9 Set up

9.1 Unpacking the balance

The balances are delivered in an environmentally-friendly package, specifically developed for this precision instrument, which provides optimum protection for the balance during transportation.

! NOTE

Retain the original packaging in order to avoid transportation damages when shipping or transporting the balance and to allow the balance to be stored in the best conditions if it is out of operation for an extended period.

In order to avoid damage, attention must be given to the following points when unpacking the balance:

- Unpack the balance carefully. It is a precision instrument.
- When outside temperatures are very low, the balance should first be stored for some hours in the unopened transport package in a dry room at normal temperature, so that no condensation settles on the balance when unpacking.
- Check the balance immediately after unpacking for externally visible damage. If you should find transport damage, please inform your Services representative immediately.
- If the balance is not to be used immediately after purchase but only at a later time, it should be stored in a dry place where fluctuations in temperature are as low as possible (see chapter 9.3 "Storage").
- Read through these operating instructions, even if you already have experience with balances, before you work with the balance and pay attention to the safety recommendations (see chapter 8 "Safety").

9.2 Transport and shipping

Your balance is a precision instrument. Treat it with care.

Avoid shaking, severe impacts and vibration during the transportation.

Take care that there are no significant temperature fluctuations during the transportation and that the balance does not become damp (condensation).

! NOTE

The balance should preferably be dispatched and transported in the original packaging to avoid transportation damage.

9.3 Storage

If you would like to take the balance out of service for an extended period, disconnect it from the electricity supply, clean it thoroughly (see chapter 22.4 "Cleaning") and store it in a place which meets the following conditions:

- No violent shaking, no vibrations
- No significant temperature fluctuations
- No direct solar radiation
- No moisture

! NOTE

The balance should preferably be stored in the original packaging, since this provides optimum protection for the balance.
--

9.4 Choosing a suitable location

The balance location must be chosen in such a way as to guarantee perfect operation of your balance, so that the allowable ambient conditions and prerequisites are met and maintained:

- Put the balance on a solid, firm and preferably vibration-proof, horizontal base
- Make sure that the balance cannot be shaken or knocked over
- Protect from direct solar radiation
- Avoid drafts and excessive temperature fluctuations

! NOTE

With difficult conditions (where the balance may be easily shaken or subject to vibration) the balance can nevertheless provide accurate results through suitable adjustment of the stability control (see chapter 10.3.5 "Weighing mode").

9.5 Connecting the balance to the mains

The following safety recommendations must be observed when connecting the balance to the mains:

! DANGER

The balance may only be operated with the power adaptor supplied.

Check before connecting the power adaptor to the mains supply that the operating voltage stated on the balance or on the power adaptor agrees with the local mains voltage.

If the operating voltage is not the same as the mains voltage, the balance or the power adaptor must on no account be connected to the mains supply. Contact the Customer Service.

9.6 Levelling

To function properly, the balance must be precisely horizontal.

The balance is fitted with one spirit level and two adjustable feet for level-control, with the aid of which it is possible to compensate for small height differences and/or unevennesses in the surface on which the balance is standing.

The two screw feet must be adjusted so that the air bubble is precisely in the centre of the sight glass of the bubble level.

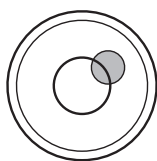

Incorrect

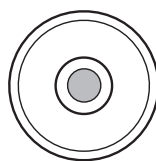

Correct

! NOTE

In order to get exact measurements, the balance must again be carefully levelled after each relocation.

9.7 Calibration of the balance

Since the Earth's gravity is not the same everywhere, each balance must – in accordance with the underlying physical weighing principle – be adjusted to compensate for the gravity at each location. This adjustment process, known as "calibration", must be carried out on initial installation and after each subsequent relocation. In order to get exact measurements, it is recommended moreover, that the balance should also be calibrated periodically.

! NOTE

The balance must be calibrated on initial installation and after every relocation.
If you work in accordance with "Good Laboratory Practice GLP" observe the prescribed intervals between calibrations (adjustments).

Calibration is effected in the configuration menu. Depending on the balance model, this may be done externally, internally or automatically (see chapter 10.3.4 "Calibration functions" and see chapter 22.1 "Calibration").

With the aid of the "Intelligent Calibration Mode" the balance can itself determine the size of the calibration weight, which enables an exact calibration with different size weights (in 10 g, 50 g, 100 g and 500 g steps, depending on implementation).

9.8 Dual Range and Floating Range balances

With the Dual Range balances, weighing is always first carried out in the fine range, which is 10 times more precise. When the fine range is exceeded the balance switches automatically into the coarse range.

The Floating Range balances have a fine range (10 times more precise), which moves over the entire weight range. By pressing the tare key «T» the fine range can be called up as often as required over the entire weight range.

9.9 Standardized balance

The standardized balances are provided with the EC/OIML certification or meet the local standardisation regulations.

The balance range and certain functions of the weighing output differ from the standard program in the case of the standardized balances – in accordance with the EC/OIML provisions.

! NOTE

If a circle appears in the main-display of a standardized balance, the indicated value is unstandardised.
In balances of class (1) the circle also stands for the warm-up phase.
Your Customer Service will be happy to assist you at any time if you have any questions on the standardization of the balance or on working with standardized balances.

9.10 Switching on the balance

- Press «ON/OFF» to switch on the balance.

The balance carries out a diagnostic test in order to check the most important functions. After completion of the start-up process (approximately ten seconds) "Zero" appears in the display.

The balance is ready for operation and is in the Weighing mode.

9.11 Auto-Standby Mode

The balance is equipped with an Auto-Standby mode, which can be activated or deactivated in the configuration menu.

If the Auto-Standby mode is activated, the balance automatically switches to Standby some time after the last weighing or key operation (current-saving function).

The delay before switching to Standby is defined in the configuration menu (see chapter 10.3.5 "Weighing mode").

- Press any button or put on a weight in order to switch the balance from the Standby mode back to the Weighing mode again.

10 Operation

The balance has two main menus available: the configuration menu and the application menu.

The basic program of the balance is defined in the **configuration menu**. With this, you can either work with the basic configuration programmed ex-works, or define and store a user configuration adapted to your specific needs.

In the **application menu**, you may define an application program which is suited to the specific weighing problem.

In addition, you may also define the parameters for the statistics program, check-reference weighing and the user profile in the application menu.





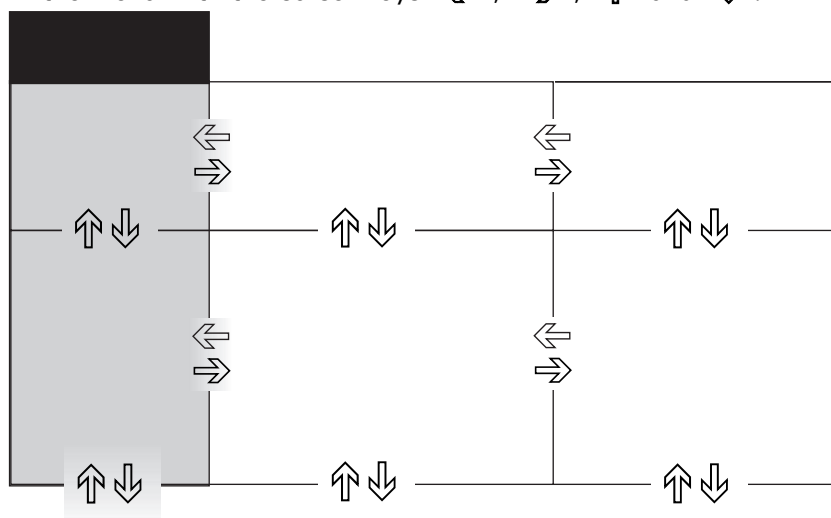

10.1 Menu control operation principle

The configuration menu and the application menu each have several menu levels in which the parameters for the different function programs of the balance are defined.

You can move within the menu with the cursor keys «←», «→», «↑» and «↓».



10.1.1 Operating in the Weighing mode















Key	Designation	Function in Weighing mode
	«ON/OFF»	• Switching the balance on and off
	«MENU»	• Calling up the Configuration Menu and the Application Menu
	«T»	• Initiate Tare Function and/or Calibration Function
	«↻»	• Switches between the Basic program and the chosen application
	«PRINT»	• Start print function
	«↑» «←» «→» «↓»	• Function keys. Start the functions in the info-line.

■ 10 Operation

! NOTE

For the operation of the «T», «» and «PRINT» see chapter 10.4 "Special operating keys".

10.1.2 Operation in the programming mode

Keys	Designation	Function in programming mode
 	«  », «  »	<ul style="list-style-type: none"> Changes within the menu level
 	«  » «  »	<ul style="list-style-type: none"> Up/Down movements within the menu Changes selected parameters
	«  »	<ul style="list-style-type: none"> Selects parameters Stores the changed parameters
	« esc »	<ul style="list-style-type: none"> Interrupts an input Leaves the menu
	« ins »	<ul style="list-style-type: none"> Places insert marker (in text entry)
	« clr »	<ul style="list-style-type: none"> Deletes input (in text entry)
	« PRINT »	<ul style="list-style-type: none"> Inputs a point (in text entry)

The balance can also be operated by remote control. For the corresponding remote control-commands see chapter 21.2 "Remote control-commands".

10.2 Setting the factory configuration

- Press «**ON/OFF**» to switch the balance on.
- During the start-up process, hold down the «T» and «**MENU**» keys until „FACTORY CONFIG.“ appears in the display, then release the keys. The balance loads the factory configuration.

10.3 Device configuration

This section explains the structure of the configuration menu and its functions.

The basic adjustment of the balance is defined in the configuration:

Menu	Definable functions
UNIT-1	Unit in which the weighing results are displayed
SET DATA PRINT	Print formats; Type of values to be printed (individual values, continuous printout, time or load change dependent values, date, time, user, etc.)
SET CALIBRATION	Calibration method
SET WEIGHING MODE	Stability mode (Quality of the balance location), Auto-Standby mode, zero correction, tare method (rapid or standard tare)
SET INTERFACE	Baud rate, parity, handshake functions of the peripheral interface
SET DATE AND TIME	Date and time (standard format or American format p.m. and a.m.)
THEFTCODE	Activating/deactivating and changing the anti-theft code.

Menu	Definable functions
KEY TONE	Activation of the keypad sound
BUS OFF	Enables disables Precisa BUS accessories
LANGUAGE	Display language (E, G, F)
BACKLIGHT	Display backlight
DRAFT SHIELD	Settings of automatic draft shield, if installed

- The settings in the sub-paths pre-programmed at the factory are printed here in **bold**.
- For greater clarity, only that part of the menu tree which corresponds to the function is shown with each description of the function.
- You will find the entire menu tree for the configuration menu in see chapter 23.1 "Configuration menu tree".
- Explanations of the menu functions are printed in *italics*.

10.3.1 Activating the configuration menu

- Press «**ON/OFF**» to switch the balance on.
- Hold down the «**MENU**» key continuously during the start-up process (which takes about ten seconds) until „UNIT-1“ appears in the display.
- You can now change the configuration menu.



10.3.2 Selecting the weight unit

• UNIT-1		
UNIT-1	g	<i>Gram</i>
	kg	<i>Kilogram</i>
	----	----
	Bht	<i>Baht</i>







The balance can show results in different units, although with some balances display is not possible in milligram or kilogram because of the corresponding weight range.

Display	Weight unit	Conversion to gram
g	Gram	
(mg)	Milligram	0,001 g
(kg)	Kilogram	1000 g
GN	Grain	0,06479891 g
dwt	Pennyweight	1,555174 g
ozt	Troy ounce	31,10347 g
oz	Ounce	28,34952 g
Lb	Pound	453,59237 g
ct	Carat	0,2 g
C.M.	Carat Metric	0,2 g
tLH	Tael Hong Kong	37,4290 g
tLM	Tael Malaysia	37,799366256 g
tLT	Tael Taiwan	37,5 g
mo	Momme	3,75 g
t	Tola	11.6638038 g
Bht	Baht	15.2 g

Procedure for changing the weight unit:

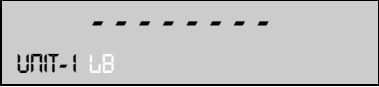
Display	Key	Step
		Press repeatedly, until „UNIT-1“ is displayed.

■ 10 Operation

Display	Key	Step
	«  »	The unit now flashes
	 »	Press repeatedly, until the unit you require appears.
	«  »	To confirm the choice of unit.

10.3.3 Print functions

• SET DATA PRINT		
AUTOSTART	ON/OFF	Start print automatically on switching on/off
MODE	UNSTABLE	Individual print, each value
	STABLE	Individual print, stable value
	LOADCHANGE	Print after load changes
	CONTINUOUS	Continuous print after every integration time
	TIMEBASE	Continuous print with time basis
TIMEBASE	2.0	Time basis (in seconds) freely selectable
SET PRINTFORMAT	DATE AND TIME	ON/OFF
	BALANCE-ID	ON/OFF
	PRODUCT-ID	ON/OFF
	GROSS AND TARE	ON/OFF
	UNITS	ON/OFF
	USER	ON/OFF
	LINEFEED	OFF/1/2/..9/FROMFEED
	PRODUCT	ttt...
	PRODUCTMODE	HOLD
		DELETE
	COUNT	

„SET PRINTFORMAT“

Elements which are switched on are printed in each case.

„UNITS“

All currently active units are printed out.

„PRODUCT ttt...“

The product name can be entered alpha-numerically.

„PRODUKTMODE“

- „HOLD“: The product name is stored.
- „DELETE“: The product name is deleted after each expression.
- „COUNT“: A counter, which is incremented by 1 after each expression is printed.

When a peripheral device (for example a printer) is connected, the balance interface must be configured in the sub-menu „SET INTERFACE“ (see chapter 10.3.6 "Interface functions").

10.3.4 Calibration functions

• SET CALIBRATION		
MODE	OFF	Closed
	EXTERNAL	External
	EXT.-DEF.	External with user-defined weight („DEF. n.nnn g“)
	INTERNAL	with internal weight
	AUTO	Automatic (AUTOCAL)

	DEF.	0.000 g	<i>Calibration weight for EXT.-DEF. mode</i>
	AUTOCAL.	TIME/TEMP.	<i>Auto-calibration on time and temperature</i>
		TEMPERATURE	<i>Auto-calibration on temperature</i>
		TIME	<i>Auto-calibration on time</i>
AUTOCAL.-TIME	6 h	<i>Time for auto-calibration</i>	

For calibration of the balance see chapter 9.7 "Calibration of the balance" and see chapter 22.1 "Calibration". The setting depends on the balance model.

10.3.5 Weighing mode

• SET WEIGHING MODE			
	FLOATINGDISPLAY	0.08 0.16 0.32	<i>Input integration time (in seconds)</i>
	STABILITY	LOW MEDIUM HIGH	<i>Setting the stability control (instability of the balance location)</i>
	AUTO-STANDBY	OFF 0.5 MIN. 1 MIN. 5 MIN. 10 MIN.	<i>Auto-Standby not active or active after nn minutes</i>
	AUTO-ZERO	ON/OFF	<i>Automatic zero correction on/off</i>
	QUICK-TARE	ON/OFF	<i>Quick-Tare on/off</i>
	ZERO-RANGE	0.000 g	<i>Maximum weight where a zero function is performed</i>

With the aid of the Weighing mode functions, you may define the quality of the balance location (see chapter 9.4 "Choosing a suitable location").

With the aid of the „AUTO-STANDBY“ function, you can define the period of non-use before the balance automatically switches into the energy-saving mode.

! NOTE

The Auto-Standby function only works with the automatic zero-correction activated („AUTO-ZERO“).

„FLOATINGDISPLAY“

The value set for „FLOATINGDISPLAY“ defines the period after which each new measurement is displayed. For the definition of this period, the quality of the balance location is crucial. The stability control must also be set appropriately.

Recommended values:

- Optimum balance location: „FLOATINGDISPLAY 0.08“
- Good balance location: „FLOATINGDISPLAY 0.16“
- Critical balance location: „FLOATINGDISPLAY 0.32“

! NOTE

The value of the Floating Display is a function of the stability control and the balance location. For balance location, see chapter 9.4 "Choosing a suitable location" and see chapter 10.3.5 "Weighing mode".

„STABILITY“

The value set for the stability control depends on the quality of the balance location and must be correctly chosen in order to obtain optimum, reproducible results. Choose:

- Optimum balance location: „STABILITY LOW“
- Good balance location: „STABILITY MEDIUM“
- Critical balance location: „STABILITY HIGH“

■ 10 Operation

„AUTO-STANDBY“

The Auto-Standby mode turns off the balance automatically, if:

- the balance is tared and has shown "Zero" for at least 5 minutes
- the balance has received no remote control command via the interface for at least 5 minutes,
- the automatic zero correction „AUTO-ZERO“ is activated.

It is possible to re-start the balance after it has been switched off by an automatic Auto-Standby:

- Briefly press any key
- Put a weight on the balance
- Make a remote control command via the interface

„AUTO-ZERO“

If the automatic zero correction „AUTO-ZERO“ is activated, the balance always gives a stable zero (e.g. even with fluctuations in room temperature).

„ZERO-RANGE“

Defines the maximum weight to perform a zero function instead of a normal tare when pressing «T» or sending the remote command to tare. This value can be adjusted to make sure a small load is saved as tare and printed e.g. on a report as tare value.

10.3.6 Interface functions

• SET INTERFACE			
	BAUDRATE	300 600 1200 2400 4800 9600 19200 38400 57600	Select baud rate
	PARITY	7-EVEN-1STOP 7-ODD-1STOP 7-NO-2STOP 8-NO-1STOP 8-EVEN-1STOP 8-ODD-1STOP	Select parity
	HANDSHAKE	NO XON-XOFF HARDWARE	Select handshake function
	PC DIRECT MODE	ON/OFF	Select PC direct mode

The RS232/V24 interface on the device is matched to the interface of a peripheral device with the aid of the interface functions (see chapter 21 "Data transfer").

„PC DIRECT MODE“

Enables/disables the PC direct mode (see chapter 21 "Data transfer").

10.3.7 Date and time.

• SET DATE AND TIME			
	DATE	[DD.MM.YY]	Set date and time
	TIME	[HH.MM.SS]	
	FORMAT	STANDARD/US	



NOTE

If a power failure occurs, the timer continues running. If this does not happen, this indicates that the instrument's backup battery has expired and has to be replaced by the Customer Service.

10.3.8 Anti-theft encoding

The balance can be protected against theft by using a freely selectable, four-digit numerical code:

- If the anti-theft code is deactivated, the instrument can be re-started and operated after a power outage without having to enter a code.
- If the anti-theft code is activated, the instrument requires the code to be input after each power outage.
- If the code is entered incorrectly, the instrument is locked.
- If the instrument is locked, it must first be disconnected from the power supply, then reconnected and unlocked by entering the correct code.
- After seven consecutive incorrect entries, the display reads „NO ACCESS, CALL SERVICE“. In this case only a service engineer can unlock the instrument again.



NOTE

The anti-theft encoding is deactivated in the factory settings.

The **preprogrammed code** set at the factory is: **8 9 3 7**

This code is the same in all balances. Therefore, for security reasons, enter your own code.

Keep your **own code** in a safe place.

• THEFTCODE			
THEFTCODE	----	THEFT-PROTECTION ON/OFF	<i>Switch encoding on/off</i>
		NEW CODE	----
			<i>Enter a new code</i>

Procedure to activate the anti-theft encoding:

Display	Key	Step
	«↓»	<i>Press repeatedly, until the „THEFTCODE“ is displayed.</i>
	«←»	<i>The first digit in the code flashes and can be changed.</i>
	«↓»	<i>Press repeatedly, until the first digit in the code is set.</i>
	«⇒»	<i>The second digit flashes. The code can now be entered fully.</i>
	«←»	<i>Confirm the theft code.</i>
	«⇒»	<i>The theft-protection can now be set.</i>
	«←»	<i>The display flashes, and the theft-protection can be activated.</i>
	«↓»	<i>Activate the theft-protection.</i>
	«←»	<i>Confirm the theft-protection.</i>

The procedure for changing the code is as follows:

Display	Key	Step
	«↓»	<i>Press repeatedly, until „NEW CODE“ appears. Set the new code as described above.</i>

■ 10 Operation

10.3.9 Key tone

• KEY TONE	
KEY TONE	ON/OFF

Switch key tone on and off

If the key tone is switched on, a short audio signal sounds each time a key is pressed.

10.3.10 Precisa BUS

• BUS	
BUS	ON/OFF

Enables the Precisa BUS functionality, mandatory if Precisa BUS accessories are connected

To connect any Precisa BUS accessories switch the BUS to ON, else switch it OFF to have a normal RS232 communication.

10.3.11 Language function

• LANGUAGE	
SPRACHE	DEUTSCH
LANGUAGE	ENGLISH
LANGUE	FRANCAISE

Selecting a language

Procedure for changing the language:

Display	Key	Step
<div style="border: 1px solid black; padding: 5px; text-align: center;"> ----- SPRACHE DEUTSCH </div>	«↓»	<i>Press repeatedly, until the language currently activated is displayed.</i>
<div style="border: 1px solid black; padding: 5px; text-align: center;"> ----- SPRACHE DEUTSCH </div>	«←»	<i>The language now flashes.</i>
<div style="border: 1px solid black; padding: 5px; text-align: center;"> ----- LANGUAGE ENGLISH </div>	«↑»	<i>Press repeatedly until the language you require appears.</i>
<div style="border: 1px solid black; padding: 5px; text-align: center;"> ----- LANGUAGE ENGLISH </div>	«←»	<i>To confirm the choice of language.</i>

10.3.12 Backlight

• BACKLIGHT	
BACKLIGHT	6

Set the display backlight

10.3.13 Automatic draft shield

• DRAFT SHIELD				
	DOOR	SPEED	SLOW NORMAL FAST	<i>Speed of door</i>
		OPENING LEFT	1/3 2/3 FULL	<i>Opening angel of right left</i>
		OPENING RIGHT	1/3 2/3 FULL	<i>Opening angel of right door</i>
	SENSOR	ACOUSTIC SIGNAL	ON/ OFF	<i>Accoustic feedback of sensor function</i>

		SENSITIVITY	LOW MEDIUM HIGH	Sensor activation range
	SENSOR R.	OPEN LEFT		<i>Open / close left door</i>
		OPEN RIGHT		<i>Open / close right door</i>
		TARE		<i>Tare</i>
		PRINT		<i>Printout</i>
		OFF		<i>no function</i>
	SENSOR L.	OPEN LEFT		<i>Open / close left door</i>
		OPEN RIGHT		<i>Open / close right door</i>
		TARE		<i>Tare</i>
		PRINT		<i>Printout</i>
		OFF		<i>no function</i>

Settings for automatic draft shield, if assembled on balance.

10.4 Special operating keys

10.4.1 The tare key

- **Activating taring**
 - Ensure that the balance is in the Weighing mode
 - Briefly press «T»
 - The balance performs a tare operation.
- **Range selection**

(This option is only available on dual range or floating range balances)

 - Ensure that the balance is in the Weighing mode
 - Hold down «T» until „RANGE FINE ON“ or „RANGE FINE OFF“ is displayed
 - Release «T»
 - If „RANGE FINE OFF“ is selected the balance is working only in the coarse range and therefore the readability is 10 times lower than in the fine range.
- **Activating calibration**
 - Ensure that the balance is in the Weighing mode
 - Hold down «T» until „CALIBRATION“ is displayed
 - Release «T»
 - The balance carries out a calibration sequence in accordance with the settings in the configuration menu (see chapter 10.3.4 "Calibration functions") and reports these by means of a print-out.
- **Activating an automatic repeatability test (ART)**
 - Ensure that the balance is in the Weighing mode
 - Hold down «T» until „REPEATABILITY TEST“ is displayed
 - Release «T»
 - The balance carries out an automatic repeatability test and the results is printed out (see chapter 22.2 "Automatic Repeatability Test (ART)").



NOTE

The calibration can be interrupted with the «ON/OFF» key.

10.4.2 The print key

- **Print out an individual value or a report**
 - Ensure that the balance is in the Weighing mode
 - Briefly press «PRINT»
 - The individual value or report will be printed out.
- **Reset product counter to 1**
 - Ensure that the balance is in the Weighing mode
 - Hold down «PRINT» until „RESET PROD.-COUNTER“ is displayed
 - Release «PRINT»
 - The product counter will be reset to 1.

■ 10 Operation

- **Print out a balance status**
 - Ensure that the balance is in the Weighing mode
 - Hold down «**PRINT**» until „PRINT STATUS“ is displayed
 - Release «**PRINT**»
 - The balance status will be printed out.
- **Print out the application-setup**
 - Ensure that the balance is in the Weighing mode
 - Hold down «**PRINT**» until „PRINT APPLICATIONS“ is displayed
 - Release «**PRINT**»
 - The application-setup will be printed out.
- **Print out the calibration information**
 - Ensure that the balance is in the Weighing mode
 - Hold down «**PRINT**» until „PRINT CALIBRATIONS“ is displayed
 - Release «**PRINT**»
 - Information on the last 50 calibrations is printed. The time and date, as well as the temperature in the balance at the time of calibration in degrees Celsius. If more than 50 calibrations have been performed, the oldest are deleted.
- **Print out the firmware update history**
 - Ensure that the balance is in the weighing mode
 - Keep «**PRINT**» pressed until “PRINT FIRMWARE HIST” is displayed
 - Release «**PRINT**»
 - Information on the firmware which has been loaded together with the time and date is printed.

10.4.3 The change key

- **Switch to other applications**
 - As long as you hold «**↻**», all active applications are shown one after the other:
if, for example, the statistics program, the check program and the count application are activated, „WEIGHING“, „STATISTIC“, „CHECK +/-“ and „COUNT“ appear in the info-line one after the other:
 - Release «**↻**» when the application to which the balance should be switched, appears in the display.

10.5 Application menu

The balance application programs are called up using the application menu and adapted to the user's needs:

Menu	Definable functions
SET APP.	Select application program
SETUP APPLICATION	Specify parameters for the application program selected
SET STATISTICS	Statistics and storage functions
SET CHECK +/-	Define nominal weight and limits for comparison weighing
AUTO-START ON/OFF	The selected application program can, if required, be loaded automatically every time the balance is switched on
SET USER	Define user profile

- The settings for the sub-menus programmed in works are printed here in **bold**
- For greater clarity, only that part of the menu tree which corresponds to this application is shown with each application description.
- You will find the complete menu tree for the application menu in see chapter 23.2 "Application menu tree".
- Explanations of the menu functions are printed in *italics*.

10.5.1 Activating the application menu

- Press «**MENU**» after the start-up procedure has ended in order to access the application menu.

10.5.2 Selecting an application program

• SELECT APPLICATION		
SET APP.	OFF	<i>normal weighing</i>
	UNITS	<i>different weight units</i>
	COUNT	<i>Piece counting</i>
	PERCENT	<i>Percent weighing</i>
	CALCULATOR	<i>Conversions</i>
	PAPER	<i>Determine paper weight (in g / square cm)</i>
	NET-TOTAL	<i>Add weighing results with intermediate tare</i>
	SUM	<i>Add weighing results without intermediate tare</i>
	ANIMAL	<i>Animal weighing</i>

	etc.	<i>Other functions available.</i>
		<i>Refer to the chapter 11 "Application"</i>

In this function-field, select the desired application program.

If an application program is selected in the „SET APP.“ menu, then only those sub-menus, which contain functions and parameters necessary to define the chosen application program are shown in the „SETUP APPLICATION“ menu.



NOTE

Refer to the Application Operating Instructions for a description of applications which are not described in these Operating Instructions.

11 Application

11.1 Units

• SETUP APPLICATION			
UNITS	UNIT-2	mg	Milligram
		----	----
		OFF	not active
	UNIT-3	GN	Grain
		----	----
		OFF	not active
UNIT-4	ct	Carat	
	----	----	
	OFF	not active	

Assigning the function keys:

Key	Function
«g»	Show measurement in unit 1, e.g. Gram
«mg»	Show measurement in unit 2, e.g. Milligramm
«GN»	Show measurement in unit 3, e.g. Grain
«ct» or «STO»	Show measurement in unit 4, e.g. Carat or Statistics functions if the statistics-program is activ

! **NOTE**

For basic operation, Unit 1 is defined in the Configuration menu (standard unit for all weighing procedures, if the application program „UNIT“ is not called up, see chapter 10.3.2 "Selecting the weight unit").

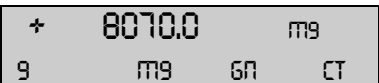
Display	Key	Step
	«↺»	Press until „UNITS“ appears.
	«⇒»	The weight is displayed as milligrams,

By pressing the relevant function key the weight display is switched to the corresponding unit. The weight is printed in the unit of measurement shown by pressing the «PRINT» key.

11.2 Count

• SETUP APPLICATION			
COUNT	KEY-1	5	Reference-number of pieces = 5
	KEY-2	10	Reference-number of pieces = 10
	KEY-3	25	Reference-number of pieces = 25
	KEY-4	50	Reference-number of pieces = 50

With the aid of the „COUNT“ program you can count items of uniform weight (screws, bearings, coins, etc.). For this, you must first weigh a defined number of items (for example 5 items) and assign the reference number of pieces to the reference weight so obtained by pressing the corresponding function key.

! **NOTE**

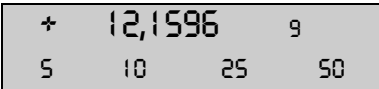
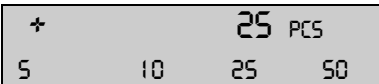

Depending on the weight and tolerances of the objects to be counted, you should count a representative number of items for the regulation of the reference-weight.

Working without Tare value:

Display	Key	Step
	«↻»	Press until „COUNT“ appears.
		apply (or remove) e.g 25 pieces
	«↑»	The weight is recalculated in pieces (PCS) and displayed. The reference quantity is set.

The quantity shown is printed by pressing the «**PRINT**» key.

Working with Tare value, manually input by hand or interface, eg. 20.0000g:

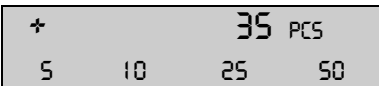
Display	Key	Step
	«↻»	Press until „COUNT“ appears.
	«↑»	25 is flashing, the point of reference is measured
	«↑»	apply (or remove) e.g 25 pieces
	«↑»	The weight is recalculated in pieces (PCS) and displayed. The reference quantity is set.



The quantity shown is printed by pressing the «**PRINT**» key.

11.3 Percent

• SETUP APPLICATION			
PERCENT	DECIMALS	AUTO 0 1 2 etc.	<i>Enter number of decimal places. The number of places that can be selected after the decimal point depends on the balance model.</i>

With the aid of the „PERCENT“ program you can display and print out the weight of different measurements as a percentage of a previously defined reference weight.

Working without Tare value:

Display	Key	Step
	«↻»	Press until „PERCENT“ appears.
	«←»	Place the reference weight on the balance to set the reference weight equal to 100%.

All subsequent measurements will now be shown as percentages of the reference weight so defined.
The percentage shown is printed by pressing the «**PRINT**» key.

Working with Tare value, manually input by hand or interface, here e.g. 20.0000g:

Display	Key	Step
	«↻»	Press until „PERCENT“ appears.

■ 11 Application

Display	Key	Step
<div style="border: 1px solid black; padding: 2px;"> + 10,000 9 SET </div>	«←»	„SET“ is flashing. The point of reference is measured
<div style="border: 1px solid black; padding: 2px;"> + 30,000 9 SET </div>		apply e.g. 20.0000g
<div style="border: 1px solid black; padding: 2px;"> + 130,000 % SET </div>	«←»	The weight is recalculated in percent (%) and displayed. The reference quantity is set.

All subsequent measurements will now be shown as percentages of the reference weight so defined. The percentage shown is printed by pressing the «**PRINT**» key.

11.4 Calculator

• SETUP APPLICATION		
CALCULATOR	SET KEY-1	NAME nnnnn FACTOR n.nnn e + n MODE F * WEIGHT F / WEIGHT
	SET KEY-2	DECIMALS n DISPLAY-TEXT nnn PRINTER-TEXT nnnnnnnn
	SET KEY-3	as for key 1
	SET KEY-4	as for key 1
	SET KEY-4	as for key 1

When the „CALCULATOR“ application is activated, each of the four function keys is assigned a calculation method with the following settings.

„NAME“

Function key name, max. 5 characters.

„FACTOR“

Factor by which the weight is to be offset.

„MODE“

Multiplication of the factor by the weight or division of the factor by the weight.

„DECIMALS“

Definition of number of decimal places are to be shown in the result.

„DISPLAY TEXT“

Unit shown in the display, max. 3 characters.

„PRINTER TEXT“

Unit being printed, max. 8 characters.

In the program operation, the previously defined names of the keys appear over the function keys.

After pressing a function key, the current measurement is converted in accordance with the factor assigned and the result shown or printed out after pressing the Print key.

Thus, for example, you can convert and display the weights of sample materials of known size directly into “gram per cubic metre”.

Display	Key	Step
<div style="border: 1px solid black; padding: 2px;"> + 13,4560 9 CALCULATOR </div>	«↻»	Press until „CALCULATOR“ appears.



Display	Key	Step
	«←», «→» «↑», «↓»	The measurement is recalculated accordingly.

The calculated measurement is printed with the set printer text by pressing the «PRINT» key.

11.5 Paper

The setting up of the „PAPER” program is similar to that for the calculator (see chapter 11.4 "Calculator"). With the aid of this program you can convert and display the weights of paper samples of standard sizes directly in “gram per square metre”.

The standard variables 100 cm², 20x25 cm, A4 and 40x25 cm are set as defaults and are assigned to the function keys.

Display	Key	Step
		Hold down until „PAPER” appears.
	«←», «→» «↑», «↓»	The measurement is recalculated accordingly.

The calculated measurement is printed with the set printer text by pressing the «PRINT» key.







11.6 Net-Total

• SETUP APPLICATION	<i>There is no Setup menu for this application!</i>
NET-TOTAL	

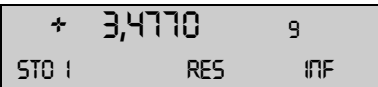
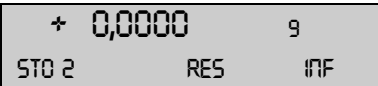
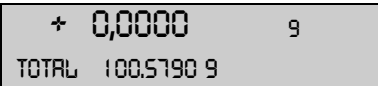

With the aid of the „NET TOTAL” program you can add individual weighing results, where the balance is tared to zero again before each individual weighing procedure.

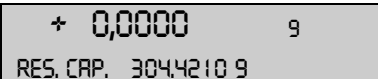
Assignment of the function keys:

Key	Function
«STO i»	Take stable value and add to the sum of the components
«WAIT i»	Value not stabilized yet
«RES»	Reset
«INF»	Change to display the total weight („TOTAL”), residual capacity („RES. CAP.”), individual values and again back to the normal display. Press «esc» to exit the INF display.

Display	Key	Step
		Press until „NET-TOTAL” appears.
	«←»	Store the stable weight applied and add it to the sum of the components; the balance is tared.
	«←»	Add further weights
Retrieve the parameters:		
		Show the info display. Display the total of the added components.
		Display the remaining capacity.

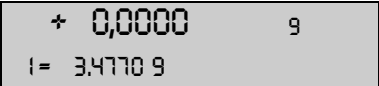
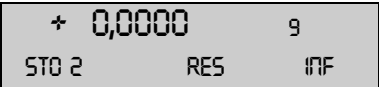
■ 11 Application

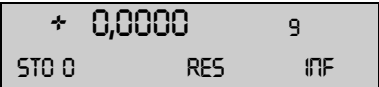
Display	Key	Step
	«↓»	Display the individual components.
	«esc»	Exit the info display.
Clear the measurements:		
	«↑»	Hold down the key until the acoustic signal sounds and the component counter is reset.
		Measurements cleared, balance is ready for a new measurement.

A measurement log is printed by pressing the «PRINT» key.

11.7 Sum



• SETUP APPLICATION	<i>There is no Setup menu for this application!</i>
SUM	

With the aid of the „SUM“ program, you can add individual weighings, without the balance being tared to zero before each individual weighing.

Assignment of the function keys:

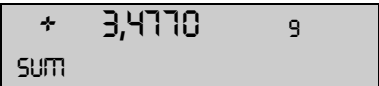
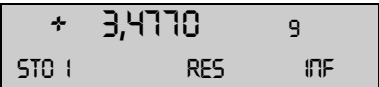
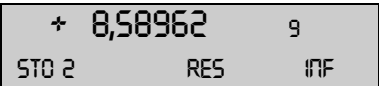
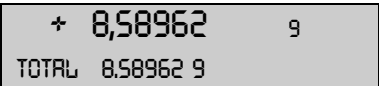
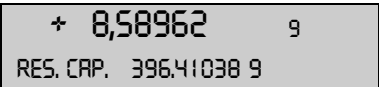
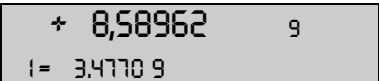
Key	Function
«STO i»	Take stable value and add to the sum of the components
«WAIT i»	Value not stabilized
«RES»	Reset
«INF»	Change to display the total weight („TOTAL“), residual capacity („RES. CAP.“), individual values and again back to the normal display. Press «esc» to exit the INF display.

Display	Key	Step
	«C»	Press until „SUM“ appears.
	«←»	Store the stable value and add it to the sum of the components.
	«←»	Add further weights.
Retrieve the parameters:		
	«↓»	Show the info display. Display the total of the added component.
	«↓»	Display the remaining capacity.
	«↓»	Display the individual components.

Display	Key	Step
	« esc »	Exit the info display.
Clear the measurements:		
	⬆	Hold down the key until the acoustic signal sounds and the component counter is reset.
		Measurements cleared, balance is ready for a new measurement.

A measurement log is printed by pressing the «**PRINT**» key.

11.8 Animal





• SETUP APPLICATION		
ANIMAL	MEASURETIME	4 Enter time in seconds

With the aid of the „ANIMAL“ program you can weigh live animals accurately, even if they move on the weighing pan.

The balance measures continuously throughout the period defined by the user in the Setup menu, averages the stored values at the end of the measuring period and displays average-measurement thus obtained.

Assignment of the function keys:

Key	Function
« MAN »	Manual release of the measurement.
« AUTO »	Automatic release of the measurement with a second delay after each load change.
« STO »	Statistics storage function if activated.

Display	Key	Step
	⌂	Press until „ANIMAL“ appears.
	⬅	Manual release of the measurement.
	➡	Automatic release of the measurement with a second delay after each load change.
		Display the measurement result; the small circle in the display is active.
	⬇	Statistics storage function if activated

The measurement result is printed by pressing the «**PRINT**» key.

English

12 Statistics

• SET STATISTICS			
STATISTICS	MODE	OFF	Statistics program off
		STATISTICS	Statistics only
		RECORDER	Data storage only
		STAT./RECORDER	Statistics and storage
	COUNT	100	Number of values to be stored automatically (1..500).
	RECORDING	MANUAL	With « STO i » function key
		TIMEBASE	on a time basis
		LOADCHANGE	after every weight change
	TIMBASE	2.0	Time base for "storage" in seconds

Functions of the statistics program and storage functions:

„MODE“

In this function-field you may define whether only the statistics-program, only the storage-program or both programs simultaneously should be used.

„COUNT“

A number of measurements is laid down, after which automatic storage is to be terminated.

„RECORDING“

„MANUAL“: The «**STO i**» function key must be pressed for each value to be stored.

„LOADCHANGE“: The balance stores the measured value automatically after a load change.

„TIMEBASE“: The balance stores every value measured after a defined period (default: 2.0 seconds).

„TIMEBASE“

Definition of the time span for the recording of data in accordance with „RECORDING TIMEBASE“ (for example, every 2.0 seconds).

!	NOTE
In storing the first value a range of $\pm 50\%$ is determined. Subsequent values must be within this range otherwise an error message will be issued.	

Assignment of the function keys:

Key	Function
« STO i »	Take value, start/stop of automatic recording
« AUTO i »	Automatic recording is running
« WAIT i »	Value not stabilized yet
« RES »	Before a new series of measurements the storage must be reset using « RES ». The key must be held down until the acoustic signal sounds and the measurement counter is reset.
« INF »	Change the display to the info display. Displayed information: - „Average value (AVERAGE)“ - „Standard deviation (STD DEV.)“ - „Relative standard deviation (STD DEV.-%)“ - „Maximum (MAX)“ - „Minimum (MIN)“ - „individual values“ Press « esc » to exit the info display.

Display	
+ 3,4770 9	
STATISTICS	

Key	Step
« C »	Press until „STATISTICS“ appears.

Display	Key	Step
<pre> + 3,4770 9 STO 0 RES INF </pre>	«←»	Record a stable measurement.
<pre> + 3,4785 9 STO 1 RES INF </pre>	«←»	Record a second measurement.
<pre> + 3,4775 9 STO 2 RES INF </pre>	«←i»	Record a third measurement.
Retrieve the parameters:		
<pre> + 0,0000 9 MEAN 3.4777 9 </pre>	«↓»	Show info display. Average measurement
<pre> + 0,0000 9 STDE. 0.00076 9 </pre>	«↓»	Standard deviation
<pre> + 0,0000 9 STDE-% 0.02 % </pre>	«↓»	Relative standard deviation
<pre> + 0,0000 9 MAX 3.4785 9 </pre>	«↓»	Maximum
<pre> + 0,0000 9 MIN 3.4770 9 </pre>	«↓»	Minimum
<pre> + 0,0000 9 1= 3.4770 9 </pre>	«↓»	Measurement 1
<pre> + 0,0000 9 2= 3.4785 9 </pre>	«↓»	Measurement 2, etc.
<pre> + 3,4775 9 STO 2 RES INF </pre>	«esc»	Exit info display.
Clear measurements:		
<pre> + 3,4775 9 STO 2 RES INF </pre>	«↑»	Hold down the key until the acoustic signal sounds and the measurement counter is reset.
<pre> + 3,4775 9 STO 0 RES INF </pre>		Measurement cleared, balance ready for new statistics.

A statistics log is printed by pressing the «**PRINT**» key.

13 Check-Weighing

• SET CHECK +/-

CHECK +/-	MODE	ON/OFF	Switch application on/off
	NOM.	100.000 g	Enter nominal weight
	TO	120.000 g	Define over limit
	TU	80.000 g	Define under limit

With the aid of the „CHECK +/-“ program you can check each measurement for its agreement with a defined reference-value plus/minus allowable deviations.

- The four function keys are not active.
- In the display „+“, „-“ and „→II←“ are active.
If „→II←“ lights up, the measured value lies within the specified tolerances.



NOTE

As an accessory, a signal light is available for this type of display (see Accessories).

Display

+ 0,0000 9
CHECK +/-

Key



Step

Press until „CHECK +/-“ appears.
The check application is activated.

■ 14 Density ("DENSITY")

14 Density ("DENSITY")

14.1 Explanatory notes on density determination

14.1.1 Methods of determination

You can use the "DENSITY" workflow to determine the density of solids and liquids.

You can choose between different methods of determination:

- "MODE LIQUID" : Density of a liquid (only with density determination kit 350-8515)
- "MODE SOLID IN AIR" : Density of a solid
- "MODE SOLID POROUS" : Density of a porous solid
- "MODE SOLID ON BOTTOM" : Density of a solid with a vessel on the weighing pan

14.1.2 Density index calculation

The density index indicates the percentage difference between two densities:

$$\text{Index} = \frac{\text{density}_1 - \text{density}_2}{\text{density}_1} \cdot 100 \%$$

The two densities are used such that density₁ is always \geq density₂.

Either two consecutive densities are compared, or the last density determined is compared with the input reference density.

14.2 Selecting the density determination application

In order to activate the application menu, press the «MENU» key and select the "DENSITY" application.

• SELECT APPLICATION		
SET APP.	OFF	<i>Normal weighing mode</i>

	DENSITY	<i>Density determination</i>

The submenus which are required for defining the density determination are now displayed in the "SETUP APPLICATION" menu.

14.3 Configuring the density determination

• SETUP APPLICATION		
DENSITY	MODE SOLID ON BOTTOM	<i>Solids with a vessel on the weighing pan</i>
	MODE SOLID IN AIR	<i>Solids</i>
	MODE LIQUID	<i>Liquids</i>
	MODE SOLID POROUS	<i>Porous solids</i>
	INDEX ON/OFF	<i>Index calculation on/off</i>
	REFERENCE 8.000	<i>Reference density for the index calculation in g/ccm (only used if REFERENCE < > 0.000)</i>
	TIME BASIS 2.0	<i>Time basis for repetition in seconds (only used if TIME BASIS < > 0.0)</i>
	REF. DENSITY 0.998205	<i>Density of the test liquid (Factory setting water at 20°C)</i>
TEMPERATURE 20	<i>Temperature of the water used for the measurement in °C (the REF. DENSITY is calculated accordingly)</i>	
DECIMALS 3	<i>Number of decimal places for density calculation</i>	

14.4 Starting and initializing the density program

Press «» briefly to go to the density program.

If "LIQUID MODE" is set, it goes directly to the density measurement. The following display appears in all other modes:

+	0,998205	g/ccm	<i>Current density of the test liquid</i>
OK	CRG	T-H2O	20.0C <i>Functions</i>

Configuration of the function keys:

Key	Functions
«OK»	Accept the density of the test liquid = = > Continue with the corresponding density measurement.
«KAL»	Determine the density of the test liquid (see chapter 14.5 "Density of a liquid "MODE LIQUID" (with density kit 350-8515)").
«T-H2o 20.0C»	Set the reference density of water (currently set at: 20.0°C).
«T-H2o ---C»	Set the reference density of water (currently not defined).

■ 14 Density ("DENSITY")

14.5 Density of a liquid "MODE LIQUID" (with density kit 350-8515)

This method is used to determine the density of a liquid. A glass vessel is used for this with a volume of 10 cm³ or 100 cm³.

Display	Key	Step
<div style="border: 1px solid black; padding: 2px;"> <div style="display: flex; justify-content: space-between;"> 0,000 9 </div> <div style="display: flex; justify-content: space-between;"> RIR SET </div> </div>	«T»	Taring

Hang the glass vessel from the below-balance hook (fig. 1).

<div style="border: 1px solid black; padding: 2px;"> <div style="display: flex; justify-content: space-between;"> + 24,971 9 </div> <div style="display: flex; justify-content: space-between;"> RIR SET </div> </div>	«⇒»	As soon as the reading is stable, it is saved and displayed for 2 seconds.
---	-----	--

Place the container and liquid on the balance and lower in the glass vessel (the glass vessel must not touch the bottom) (fig. 2).

<div style="border: 1px solid black; padding: 2px;"> <div style="display: flex; justify-content: space-between;"> + 14,985 9 </div> <div style="display: flex; justify-content: space-between;"> LIQUID SET </div> </div>	«⇒»	As soon as the reading is stable, it is saved and displayed for 2 seconds.
--	-----	--

<div style="border: 1px solid black; padding: 2px;"> <div style="display: flex; justify-content: space-between;"> + 0,9999 9,00CM </div> <div style="display: flex; justify-content: space-between;"> DENSITY <-> </div> </div>		Liquid density display (provided it is within the 0,5 - 2.0 g/ccm range).
--	--	---

<div style="border: 1px solid black; padding: 2px;"> <div style="display: flex; justify-content: space-between;"> + 0,20 % </div> <div style="display: flex; justify-content: space-between;"> INDEX <-> </div> </div>	«↑»	Switch to the density index display (if Index is ON).
---	-----	---

<div style="border: 1px solid black; padding: 2px;"> <div style="display: flex; justify-content: space-between;"> 0,000 9 </div> <div style="display: flex; justify-content: space-between;"> RIR SET </div> </div>	«T»	Taring, the balance returns to the gram display and is ready for the next determination.
---	-----	--

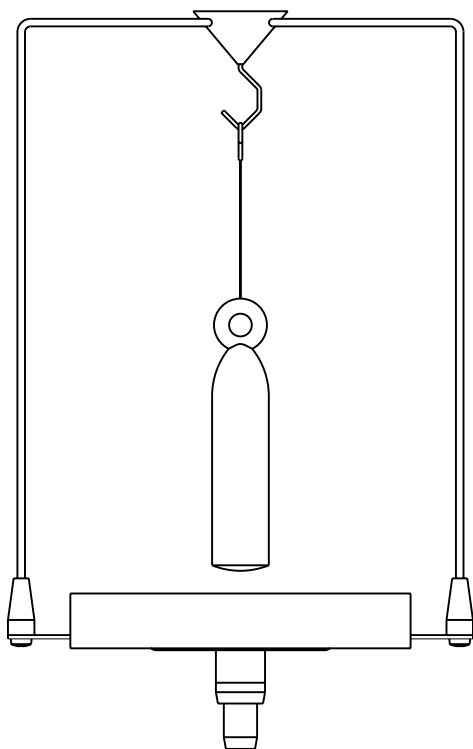

fig. 1

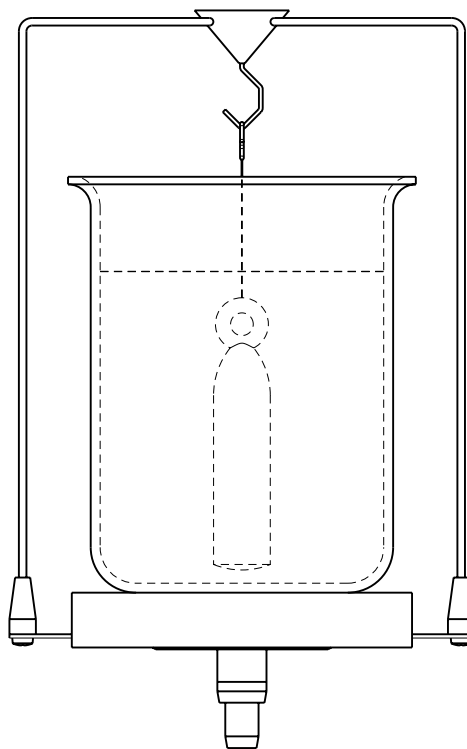

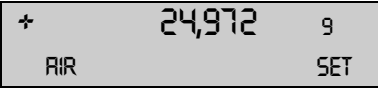
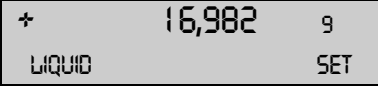
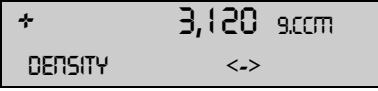



fig. 2

14.6 Density of a solid "MODE SOLID IN AIR"

This method is used to determine the density of a solid. The double beaker is required for this. The thermometer is used to monitor the temperature of the test liquid in the container.

Display	Key	Step
	«T»	Taring
Place the solid into the top beaker (fig. 3 resp 3a).		
	«⇒»	As soon as the reading is stable, it is saved and displayed for 2 seconds.
Place the solid into the bottom beaker (fig. 4 resp 4a).		
	«⇒»	As soon as the reading is stable, it is saved and displayed for 2 seconds.
		Solid density display (provided it is within the 0,1 - 25.0 g/ccm range).
	«↑»	Switch to the density index display (if Index is ON).
	«T»	Taring, the balance returns to the gram display and is ready for the next determination.

Density determination using a density determination set Order number see Accessories series 320

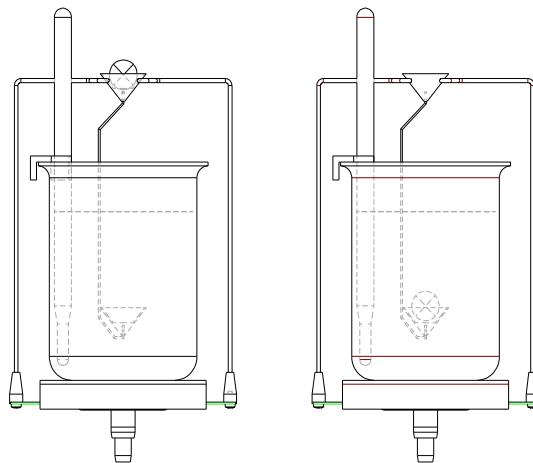

fig. 3

fig. 4

Density determination using below balance weighing Order number see Accessories of the respective series

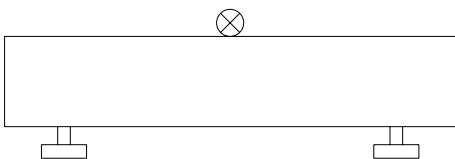

fig. 3a

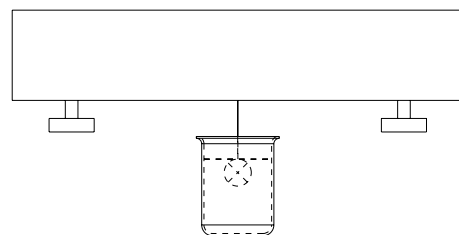

fig. 4a

■ 14 Density ("DENSITY")

14.7 Density of a porous solid "MODE SOLID POROUS"

This method is used to determine the density of a porous solid. The double beaker is required for this. The thermometer is used to monitor the temperature of the test liquid in the container.

Display	Key	Step
0,000 9 AIR SET	«T»	Taring

Place the porous solid into the top beaker (fig. 5 resp 5a).

+ 24,974 9 AIR SET	«⇒»	As soon as the reading is stable, it is saved and displayed for 2 seconds.
-----------------------	-----	--

Seal the pores on the solid with wax, for example. Now place the solid into the top beaker (fig. 6 resp 6a).

+ 26,971 9 CLOSED PORES SET	«⇒»	As soon as the reading is stable, it is saved and displayed for 2 seconds.
--------------------------------	-----	--

Place the solid into the bottom beaker (fig. 7 resp 7a)

+ 16,984 9 LIQUID SET	«⇒»	As soon as the reading is stable, it is saved and displayed for 2 seconds.
--------------------------	-----	--

+ 2,496 9.CCM DENSITY <->		Solid density display (provided it is within the 0,1 - 25.0 g/ccm range).
------------------------------	--	--

+ 2,05 % INDEX <->	«↑»	Switch to the density index display (if Index is ON).
-----------------------	-----	--

0,000 9 AIR SET	«T»	Taring, the balance returns to the gram display and is ready for the next determination.
--------------------	-----	--

Density determination using a density determination set Order number see Accessories series 320

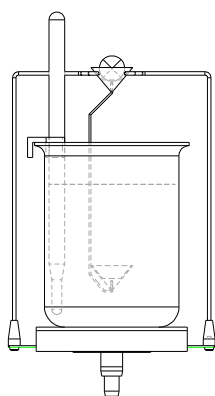

fig. 5

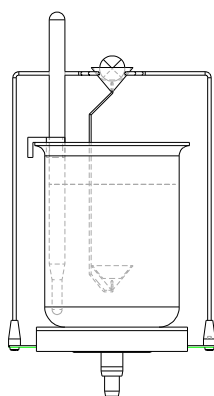

fig. 6

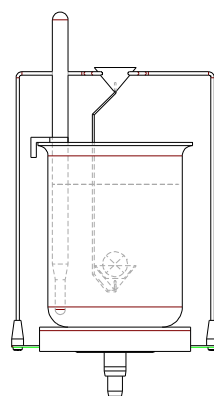

fig. 7

Density determination using below balance weighing Order number see Accessories of the respectiv series

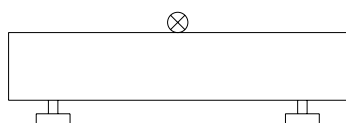

fig. 5a

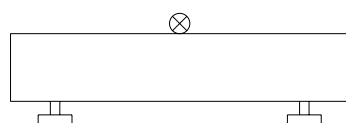

fig.6a

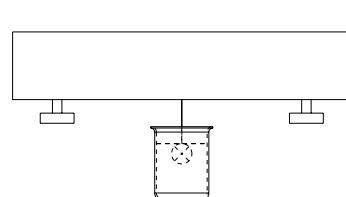

fig. 7a

14.8 Density of a solid "MODE SOLID ON THE BOTTOM"

This method is used to determine the density of a solid; however, no auxiliary apparatus is required. The thermometer is used to monitor the temperature of the test liquid.

Display	Key	Step
<div style="border: 1px solid black; padding: 5px; display: flex; justify-content: space-between;"> 0,000 9 </div> <div style="border: 1px solid black; padding: 5px; display: flex; justify-content: space-between;"> BOTTOM SET </div>	«T»	Pour the tempered reference liquid (water) into a container, place it on the balance and tare it (fig. 8)
Place the solid in the bottom of the container (fig. 9).		
<div style="border: 1px solid black; padding: 5px; display: flex; justify-content: space-between;"> + 24,971 9 </div> <div style="border: 1px solid black; padding: 5px; display: flex; justify-content: space-between;"> BOTTOM SET </div>	«⇒»	As soon as the reading is stable, it is saved and displayed for 2 seconds.
Then raise the solid off the bottom, making sure it is still be fully immersed in the test liquid (fig. 10).		
<div style="border: 1px solid black; padding: 5px; display: flex; justify-content: space-between;"> + 9,988 9 </div> <div style="border: 1px solid black; padding: 5px; display: flex; justify-content: space-between;"> LIQUID SET </div>	«⇒»	As soon as the reading is stable, it is saved and displayed for 2 seconds.
<div style="border: 1px solid black; padding: 5px; display: flex; justify-content: space-between;"> + 2,496 9.CCM </div> <div style="border: 1px solid black; padding: 5px; display: flex; justify-content: space-between;"> DENSITY <-> </div>		<i>Solid density display (provided it is within the 0,1 - 25.0 g/ccm range).</i>
<div style="border: 1px solid black; padding: 5px; display: flex; justify-content: space-between;"> + 7,36 % </div> <div style="border: 1px solid black; padding: 5px; display: flex; justify-content: space-between;"> INDEX <-> </div>	«↑»	<i>Switch to the density index display (if Index is ON).</i>
<div style="border: 1px solid black; padding: 5px; display: flex; justify-content: space-between;"> 0,000 9 </div> <div style="border: 1px solid black; padding: 5px; display: flex; justify-content: space-between;"> BOTTOM SET </div>	«T»	<i>Taring, the balance returns to the gram display and is ready for the next determination.</i>

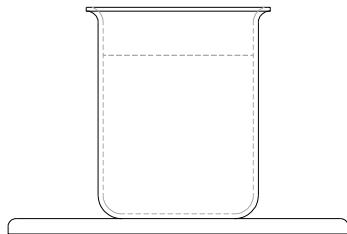

fig. 8

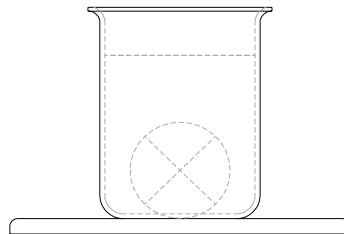

fig. 9

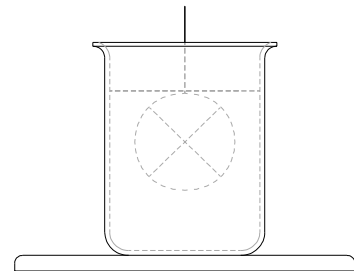

fig. 10

■ 15 Differential weighing ("DIFF.-WEIGHT")

15 Differential weighing ("DIFF.-WEIGHT")

15.1 Explanatory notes on differential weighing

In the application differential weighing, samples are investigated for weight changes, the results logged in a report and collated in statistics.

In differential weighing the original weight of a sample is determined at the start of a measurement. Following the treatment of the sample, e.g. drying, ashing, vapor-depositing, coating, etc., the sample is re-weighed, and the balance determines the difference between the two measurements. Each sample can be re-weighed up to three times. There is a selection of different units available for the display of the results. Up to 500 samples can be measured, divided into a maximum of 10 groups. Statistics are compiled for each individual group.

There are four semi-automatic measuring sequences available for recording the measurements:

- Individual measuring sequence
Record complete sample details with the tare weight, original weight and residual weight(s). Then move on to the next sample.
- Group 1 measuring sequence
Record the tare weight and original weight of all the samples in a group at the start. Then determine all the residual weights for a sample and, after that, measure the residual weights for the next sample.
- Group 2 measuring sequence
Record the tare weight and original weight of all the samples in a group at the start. Then determine the first residual weight for all the samples, followed by the second residual weight for all the samples, etc.
- Series measuring sequence
First of all enter the tare weights of all the samples in the group, then record the original weights of all the samples and, after that, re-weigh all the samples.

15.2 Selecting the differential weighing application

In order to activate the application menu, press the «MENU» key and select the "DIFF.-WEIGHT" application.

• SELECT APPLICATION		
SET APP.	OFF	Normal weighing mode

	DIFF.-WEIGHT	Differential weighing

The submenus which are required for defining the differential weighing are now displayed in the "SETUP APPLICATION" menu.

15.3 Configuring the differential weighing

Various user-specific settings for the application differential weighing can be defined in the menu under "SETUP APPLICATION".

15.3.1 Overview

• SETUP APPLICATION		
DIFF.-WEIGHT	GROUP	1
	NAME	nnn
	MODE	SINGLE GROUP1 GROUP2 SERIES
	TARE WEIGHING	ON/OFF

	UNIT	WEIGHT LOSS LOSS % RESIDUAL % ATRO 1 ATRO 2 CALCULATED	<i>in the current unit of weight</i>
	DECIMALS	2	
	FACTOR	n.nnn e + n	<i>only if the "CALCULATED" unit has been selected</i>
	MODE	F * DIFF. F / DIFF.	<i>only if the "CALCULATED" unit has been selected</i>
	SET PRINT FORMAT		SAMPLE ID ON/OFF TIME ON/OFF TARE ON/OFF INITAL ON/OFF RESIDUAL ON/OFF

"GROUP"

Setting for the current group; 10 groups are possible.

The maximum of 500 samples which are possible can be freely distributed to the individual groups.

"NAME"

Definition of the group name with up to 10 characters. If all the samples in a group are deleted, the name of the group remains. The group name can only be deleted or changed in the menu under "SETUP APPLICATION".

"MODE"

There is a selection of four different measurement recording options (see chapter 15.4.1 "Mode, measurement recording").

"TARE WEIGHING"

Switching off the tare measurement. If the tare measurement function is switched off, this applies to all the measured samples.

"UNIT"

Setting for the unit in which the differential weight is to be calculated (see chapter 15.3.2 "Units").

"DECIMALS"

Definition of the number of decimal places to be shown in the result. The "WEIGHT LOSS" unit is displayed with the setting for the balance's current unit of weight.

"FACTOR"

Entry of the factor with which the difference in weight is to be offset. This option is only activated if the "CALCULATED" unit is selected.

"MODE"

Calculation method selection.

- Multiplying the factor by the difference between the original weight and the residual weight.
- Dividing the factor by the difference between the original weight and the residual weight.

This option is only activated if the "CALCULATED" unit is selected.

"SET PRINT FORMAT"

Definition of the report. The options marked "ON" are contained in the report and are printed (see chapter 15.4.6 "Report").

15.3.2 Units

The result of a differential weighing is displayed and printed for all the samples in the set unit. If the unit is changed, the analysis changes the calculation of the results for all the samples which have been measured previously. The selected unit is also used for the statistical analysis of a group.

■ 15 Differential weighing ("DIFF.-WEIGHT")

Calculation of the units:

Unit	Calculation
"WEIGHT LOSS":	$-(I - R)$
"LOSS %" (loss in percent):	$-\frac{I - R}{I} \cdot 100\%$
"RESIDUAL %" (residue in percent):	$\frac{R}{I} \cdot 100\%$
"ATRO 1" (dry mass):	$\frac{I}{R} \cdot 100\%$
"ATRO 2" (moisture):	$-\frac{I - R}{R} \cdot 100\%$
"CALCULATED" (calculated with a factor F):	$(I - R) \cdot F$ or $\frac{F}{I - R}$

I: Original weight

R: Residual weight

F: Factor

15.4 Working with differential weighing

Press «» briefly to go to differential weighing.

SET	GET	DEL	STA
-----	-----	-----	-----

Main menu differential weighing

Configuration of the function keys:

Key	Functions
«SET»	To start the measurement recording for the set group. In the case of an empty group, start with the first sample. If samples have already been recorded in this group, start from the position where the measurement recording process was interrupted.
«GET»	To get a measured sample. The set mode is switched to single until «GET» is exited by pressing the «esc» key. The selected sample is started from the position where the measurement recording process was interrupted.
«DEL»	Activates the Delete submenu. The user can delete individual samples, a whole group or all the read samples (see chapter 15.4.4 "Deleting samples, groups").
«STA»	To get a measured sample. The set mode is switched to single until «STA» is exited by pressing the «esc» key. The selected sample is started from the position where the measurement recording process was interrupted.

15.4.1 Mode, measurement recording

There are four different options available for semiautomatic measurement recording.

Key:

T: Tare

I: Original weight

R1-R3: Residual weight 1-3

Single

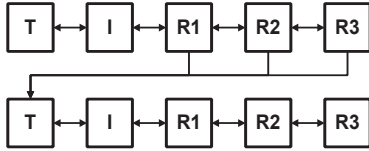

The tare weight, original weight and residual weight are recorded in consecutive order for each sample. Once the measurements for one sample have ended, the next one can be started.

Group 1

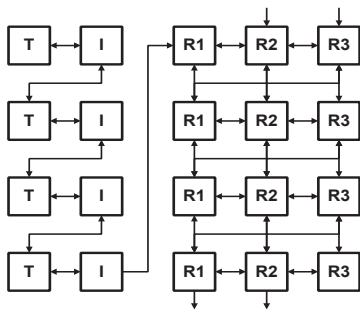

The tare weight and original weight for each sample are recorded at the start. The residual weights are then measured for all the samples.

Group 2

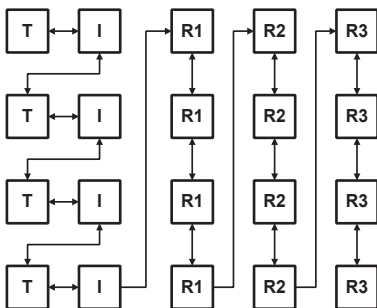

The tare weight and original weight for each sample are recorded at the start. Then determine the first residual weight for all the samples, followed by the second residual weight for all the samples, etc.

Series

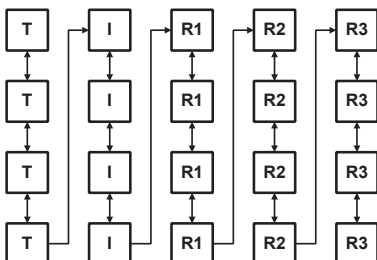

The tare weight is measured for each sample at the start. Then record the original weight for all the samples and, after that, re-weigh all the samples.

Navigation

The differential weighing program works with semiautomatic measurement recording. Once one value has been measured, the program automatically navigates to the next one.

The user can navigate between the measured values using the arrow keys, as shown by the arrows in the graphics. If a reading has been measured incorrectly, the user can navigate back to it with the arrow keys provided this navigation is possible (see the graphic for the set mode).

■ 15 Differential weighing ("DIFF.-WEIGHT")

If a reading has not been taken, the user cannot move on to the next one yet.

Navigation in single mode

The navigation for residual weights 2 and 3 must be done manually. The user gets to the next sample by pressing the «↓» key.

Navigation in group 1 mode

The automatic navigation switches from tare weight to original weight for sample 1, followed by the tare weight and then original weight for sample 2, etc. Once all the original weights for the group have been measured, the user can switch to residual weight 1 for the first sample by pressing the «⇒» key.

The navigation for residual weights 2 and 3 must be done manually, which is also the case for switching to residual weight 1 for the next sample.

Once residual weights 1 or 2 for the last sample have been measured, the user can move on to residual weights 2 or 3 for the first sample by pressing the «↓» key.

Navigation in group 2 mode

As in group 1 mode, the automatic navigation switches from tare weight to original weighting for sample 1, followed by the tare weight and then original weight for sample 2, etc. Once all the original weights for the group have been measured, the user can switch to residual weight 1 for the first sample by pressing the «⇒» key.

Subsequent navigation takes place automatically until all the readings in the group have been measured.

Navigation in series mode

Automatic navigation switches from tare sample 1 to tare sample 2, etc. Once all the tare weights for the series have been measured, the user can switch to the original weight for the first sample by pressing «⇒».

Subsequent navigation takes place automatically until all the readings in the series have been measured.

Press «esc» to return to the main menu.

15.4.2 Measurement

A differential weighing sequence is explained on the basis of an example. The balance must be switched on, and the application differential weighing must be activated.

During the measurement, the right «T» key corresponds to the «↵» key and is used to accept the measurement. The left «T» key is required to tare the balance.

+	0,00015	g	<i>Measurement line</i>
1-2 T	+ 0,00015	g	<i>Info line</i>

Measurement line:

Display the gross weight. The active balance unit is used as the weight unit.

Info line:

"1-2": Number of the current group (1) and sample number (2)

"T": Weight reading (tare) being measured

" + 0.00015 g": The weight reading displayed always corresponds to the net weight of the sample.

"GROUP 1" mode is set and group 1 selected for the example. There are no samples in the selected group 1 yet. The result is indicated in the "LOSS %" unit with 2 decimal places.

Display	Key	Step
SET GET DEL STR	«↵»	<i>Start the differential weighing.</i>
+	0,00015	g
1-1 T	+ 0,00015	g
	«T»-left	<i>If necessary, tare the balance.</i>
+	0,00000	g
1-1 T	+ 0,00000	g
		<i>Measure tare value 1, i.e. place on an empty container 1.</i>

The right «T» key corresponds to «↵» and is used to accept the measurement reading.

Display	Key	Step						
<table border="1"> <tr><td>+</td><td>15,85000</td><td>g</td></tr> <tr><td>1-1 T</td><td>+ 15,85000</td><td>g</td></tr> </table>	+	15,85000	g	1-1 T	+ 15,85000	g	«⇐»	Accept tare weight 1.
+	15,85000	g						
1-1 T	+ 15,85000	g						
<table border="1"> <tr><td>+</td><td>15,85000</td><td>g</td></tr> <tr><td>1-1 I</td><td>+ 0,00000</td><td>g</td></tr> </table>	+	15,85000	g	1-1 I	+ 0,00000	g		Fill container 1 with original weight 1 and place it on.
+	15,85000	g						
1-1 I	+ 0,00000	g						
<table border="1"> <tr><td>+</td><td>56,10000</td><td>g</td></tr> <tr><td>1-1 I</td><td>+ 40,25000</td><td>g</td></tr> </table>	+	56,10000	g	1-1 I	+ 40,25000	g	«⇐»	Accept original weight 1.
+	56,10000	g						
1-1 I	+ 40,25000	g						

As group 1 mode is set, the program automatically switches to the tare measurement for sample 2. Remove original weight 1 from the weighing pan and, if necessary, tare the balance.

<table border="1"> <tr><td>+</td><td>0,00000</td><td>g</td></tr> <tr><td>1-2 T</td><td>+0,00000</td><td>g</td></tr> </table>	+	0,00000	g	1-2 T	+0,00000	g		Measure tare weight 2, i.e. place on empty container 2.
+	0,00000	g						
1-2 T	+0,00000	g						
<table border="1"> <tr><td>+</td><td>15,87504</td><td>g</td></tr> <tr><td>1-2 T</td><td>+ 15,87504</td><td>g</td></tr> </table>	+	15,87504	g	1-2 T	+ 15,87504	g	«⇐»	Accept tare weight 2.
+	15,87504	g						
1-2 T	+ 15,87504	g						
<table border="1"> <tr><td>+</td><td>15,87504</td><td>g</td></tr> <tr><td>1-2 I</td><td>+ 0,00000</td><td>g</td></tr> </table>	+	15,87504	g	1-2 I	+ 0,00000	g		Fill the container with original weight 2 and place it on.
+	15,87504	g						
1-2 I	+ 0,00000	g						
<table border="1"> <tr><td>+</td><td>54,53186</td><td>g</td></tr> <tr><td>1-2 I</td><td>+ 38,65682</td><td>g</td></tr> </table>	+	54,53186	g	1-2 I	+ 38,65682	g	«⇐»	Accept original weight 2.
+	54,53186	g						
1-2 I	+ 38,65682	g						

As group 1 mode is set, the program switches automatically to the tare measurement for sample 3.

<table border="1"> <tr><td>+</td><td>54,53186</td><td>g</td></tr> <tr><td>1-3 T</td><td>+ 54,53186</td><td>g</td></tr> </table>	+	54,53186	g	1-3 T	+ 54,53186	g	«⇒»	Switch to residual weight 1 for the first sample.
+	54,53186	g						
1-3 T	+ 54,53186	g						

If necessary, tare the balance. The negative weight reading in the info line corresponds to tare weight 1.

<table border="1"> <tr><td>+</td><td>0,00000</td><td>g</td></tr> <tr><td>1-1 RI</td><td>- 15,85000</td><td>g</td></tr> </table>	+	0,00000	g	1-1 RI	- 15,85000	g		Place residual weight 1 for the first sample (including the container) on the balance.
+	0,00000	g						
1-1 RI	- 15,85000	g						
<table border="1"> <tr><td>+</td><td>50,32364</td><td>g</td></tr> <tr><td>1-1 RI</td><td>+ 34,57364</td><td>g</td></tr> </table>	+	50,32364	g	1-1 RI	+ 34,57364	g	«⇐»	Accept residual weight 1.
+	50,32364	g						
1-1 RI	+ 34,57364	g						
<table border="1"> <tr><td>-</td><td>14,10</td><td>%</td></tr> <tr><td>1-1 DIFF1</td><td></td><td></td></tr> </table>	-	14,10	%	1-1 DIFF1				Display the result of residual weight 1. (Loss in percent). Print out the sample report.
-	14,10	%						
1-1 DIFF1								

In order to measure a second residual weight for the same sample, press the «⇒» key. In order to determine the residual weight 1 in the second sample, press the «⇓» key.

15.4.3 Sample information

The user can switch to the info display for the current sample during the measurement recording by pressing «C».

Configuration of the function keys:

Key	Functions
«⇐», «⇒»	In the measurement display: switch between the readings shown In the results display: switch back to the measurement display
«⇑», «⇓»	If a residual weight is displayed: switch to the results display In the results display: switch to the result unit
«esc»	Exits the info display
«PRINT»	Prints the sample info, including all the measurement readings The result is printed in all the units (see chapter 15.4.6 "Report").

■ 15 Differential weighing ("DIFF.-WEIGHT")

15.4.4 Deleting samples, groups

Press the «DEL» function key to go to the Delete submenu in the main menu.



Configuration of the function keys:

Key	Functions
«-S-»	Delete a single sample. The sample to be deleted can be selected by pressing the «↑», «↓» keys. The sample is selected by pressing the «←» key.
«-G-»	Delete all the samples in the selected group. The group to be deleted can be determined by pressing the «↑», «↓» keys. The group is selected by pressing the «←» key.
«ALL»	Delete all the saved samples. As a safeguard, the deleting process must be confirmed by selecting "YES" and pressing «←». Nothing is deleted if the user selects "NO" or presses «esc».

Press «esc» to exit the deleting process at any time without deleting.

15.4.5 Statistics

Press the «STA» function key to go to the Statistics submenu in the main menu.

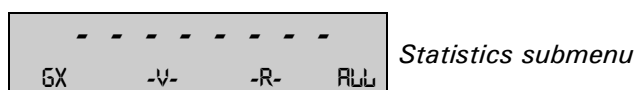

Configuration of the function keys:

Key	Functions
«-Gx-»	Select the group for which statistics are to be compiled. "x" indicates the active group.
«-V-»	Prints the measurement readings for all the samples in the selected group. The result is only printed in the unit which is set.
«-R-»	Prints the statistics on the results for the selected group.
«ALL»	Starts the Statistics printout submenu.

15.4.5.1 Statistics printout

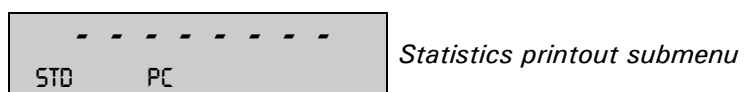

Configuration of the function keys:

Key	Functions
«STD»	Prints the measurement readings for all the samples and the statistics on the results for the selected group. The result is only printed in the unit which is set.
«PC»	Prints measurement readings and statistics on all the samples in the selected group in tabular form. The individual values are separated by a tab.

15.4.6 Report

The differential weighing report is printed after every residual weighing. Individual options in the report can be switched on and off.

If the «PRINT» key is pressed in sample information, the result is output in all the units.

If the «PRINT» key is pressed during the recording of the measurements, the current weight is printed in the

current unit. If the result is displayed, the differential weighing report is printed.

Date 10.04.2004 Time 10:05:30	<i>Date and time, if they are switched on. (Can be set in the Configuration menu)</i>
Name : XR 125 SN Software : V00-0000 P00 Serialno : 3300-001	<i>Balance ID, if it is switched on. (Can be set in the Configuration menu)</i>
Sample : 1-1	<i>Sample ID, if it is switched on.</i>
Tare : + 15.85000 g Time : 08:15:25 10.04.04	<i>Tare and time, if they are switched on.</i>
Initial : +40.25000 g Time : 08:16:32 10.04.04	<i>Original weight and time, if they are switched on.</i>
Residual 1 : +34.57364 g Time : 09:48:12 10.04.04	<i>Residual weight 1 and time, if they are switched on.</i>
Lost : + 14.10 %	<i>Result of the differential weighing</i>
User : MUSTER	<i>Operator ID, if this is switched on. (Can be set in the Configuration menu)</i>

The statistics output with the options which can be selected.

Date 10.04.2004 Time 10:05:30	<i>Date and time, if they are switched on. (Can be set in the Configuration menu)</i>
Name : XR 125 SN Software : V00-0000 P00 Serialno : 3300-001	<i>Balance ID, if it is switched on. (Can be set in the Configuration menu)</i>
Group : 1	<i>Group name; if there is no group name defined, the number is output.</i>
Residual 1: Values : 2 Mean : - 45.95 % StdE : + 5.93 % StdE% : - 12.90 % Max : - 41.76 % Min : - 50.14 %	<i>Statistics on residual weight 1</i>
Residual 2: Values : 1	<i>Statistics on residual weight 2</i>
Residual 3: Values : 0	<i>Statistics on residual weight 3</i>
User : MUSTER	<i>Operator ID, if this is switched on (Can be set in the Configuration menu)</i>

If no statistics can be compiled on the residual weight, only the number of values is output. A minimum of 2 values is required for statistics.

15.4.7 Remote control commands

Command	Function
ADWSTATE	Returns the status of the sample memory. -Number of samples saved -Number of samples still to be saved -Number of samples per group
ADWx y	Prints the entire statistics, with measured values, on one or all of the groups. x defined the format. x = 0 standard format x = 1 PC format (separated by tabs) y indicates the group. y = 0 all groups y = 1..10 group y

■ 16 Minimum original weight ("MIN.-WEIGHT")

16 Minimum original weight ("MIN.-WEIGHT")

16.1 Explanatory notes on the minimum sample weight application, MSW

MSW application is a minimum original weight solution which enables you to fulfill QM guidelines, such as GLP, GMP or USP.

16.1.1 Minimum original weight and quality management

Only very small quantities are used in many applications and, thus, only a small part of the balance's weighing capacity is used. However, the lower the original weight, the greater the relative measuring uncertainty.

What is the minimum original weight necessary to enable the quality management tolerance limits to be complied?

The minimum original weight which is required is determined on the basis of the QM criteria and of the statistical data from repeated weighing procedures.

If the weight is below the minimum original weight, a warning appears on the balance display warning you of this; these values are also marked in the printout.

- The **requisite minimum original weights** should be elicited on the basis of the QM specifications by means of the statistical analysis of certain series of measurements.
(The balance's own "STATISTIC" function could be used for this purpose, for example. It is used to perform and subsequently log the requisite series of measurements.)
- Once the minimum original weight(s) has/have been determined, it/they can be input into the balance. Up to three tare ranges can be defined with the corresponding minimum original weights.

The balance's weighing modes, as well as measuring time and stability, are also fixed in such a way as to guarantee compliance with tolerances in future measurements.

Tare ranges, minimum original weights and weighing modes cannot be changed by the user.

- The values which are input can be logged by means of an application status print and could, along with the report on the statistical measurement series, be used as a **QM certificate**.
If work is performed on the basis of the minimum original weight application, this serves to ensure that the weighing results conform to the certificate specifications and, thus, to your QM guidelines.

16.2 Selecting the minimum original weight application

In order to activate the application menu, press the «MENU» key and select the "MIN.-WEIGHT" application.

• SELECT APPLICATION		
SET APP.	OFF	<i>Normal weighing mode</i>

	MIN.-WEIGHT	<i>Minimum original weight</i>

The submenus which are required for defining the minimum original weight are now displayed in the "SETUP APPLICATION" menu.

16.3 Configuring the minimum original weight

• SETUP APPLICATION				
MIN.-WEIGHT	INFO LINE	ON/OFF	Display the info line permanently	
	ZERO KEY	ON/OFF	Facilitate resetting	
	SET PRINT FORMAT	MIN. WEIGHT	ON/OFF	
	VIEW / SET PARAMETERS (CODE - - - -)	FLOATINGDISPLAY	0.16	
		STABILITY	MEDIUM	
		NEXT TEST	18 .01.05	
		TEST-PARA.	k = 3 U = 0.1%	
		RANGE 1	35.00000 g	
		MIN.WGT 1	0.07500 g	
		RANGE 2	85.00000 g	
	MIN.WGT 2	0.10500 g		
	RANGE 3	125.00000 g		
	MIN.WGT 3	0.13500 g		
	(CODE NEW	- - - -)		

16.3.1 Variable menu settings

"INFO LINE"

- ON: The minimum original weight appears permanently in the balance display. "Value under minimum original weight" is symbolized by a "P" in the balance display.
- OFF: The minimum original weight only appears in the balance display while "value under minimum original weight".

"ZERO KEY"

The reset function is assigned to the «↑» key.

This function can be used to reset the weight display to zero, although the minimum original weight which was valid previously is retained (see chapter 16.4.3 "Resetting with the function key «>0<»").

"SET PRINT FORMAT" – "MIN. WEIGHT"

The minimum original weight appears additionally in the measurement printout.

16.3.2 Non-variable menu settings

"CODE"

This authorization code (four-digit number) enables the relevant person to change the following menu settings.

! NOTE
Factory-set authorization code: 1452 / New code: _____

"FLOATINGDISPLAY"

This value relates to the quality of the balance location and must be set correctly in order to achieve optimum, reproducible results. Select:

- Optimum balance location: "FLOATINGDISPLAY 0.04" or "FLOATINGDISPLAY 0.08"
- Good balance location: "FLOATINGDISPLAY 0.16"
- Critical balance location: "FLOATINGDISPLAY 0.32"

"STABILITY"

This value relates to the quality of the balance location and must be correctly set in order to achieve optimum, reproducible results. Select:

- Optimum balance location: "STABILITY LOW"
- Good balance location: "STABILITY MEDIUM"
- Critical balance location: "STABILITY HIGH"

"NEXT TEST"

Indicates the date until which the set minimum original weights are deemed to be valid, or when the minimum original weights need to be re-determined by the quality coordinator(s).

They should be re-determined periodically in accordance with your QM specifications. This is also advisable

■ 16 Minimum original weight ("MIN.-WEIGHT")

if there is a decisive change in the weighing criteria (ambient and application conditions).

Once the date has elapsed, a warning briefly appears in the balance display when the MSW application is started.

"TEST-PARA."

You can enter a text here which describes the parameters which you have used for determining the minimum original weight (extension factor, uncertainty).

"RANGE" / "MIN.WGT. 1-3"

Up to 3 tare ranges (the upper limit is specified in each case) can be defined with the corresponding minimum original weights.

"CODE NEW"

New code definable (four-digit number).

16.4 Working with the minimum original weight

Press  briefly to go to the minimum original weight.



Configuration of the function keys:

Key	Functions
«MIN = ...»	Additional information on the minimum original weight is displayed at 2-second intervals
«>0<»	Resetting the weight display without changing the value of the minimum original weight.

16.4.1 Indicator for "value below minimum original weight"

16.4.1.1 Indicator in the balance display "MIN = ..." or "P" or

• "INFO LINE OFF"

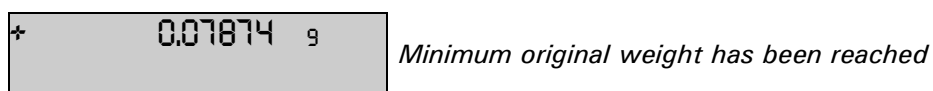
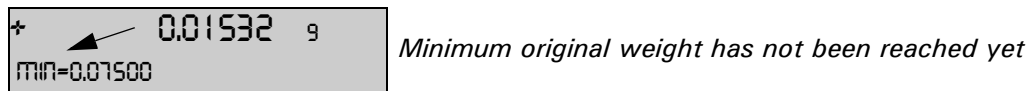

• "INFO LINE ON"

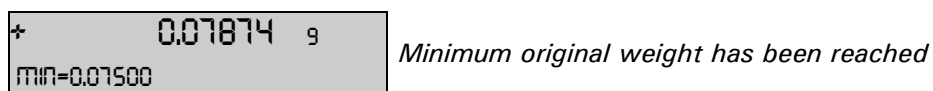
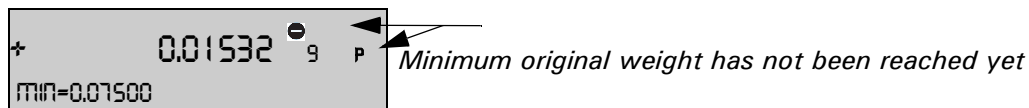

16.4.1.2 Indicator in the report printout ("*")

• "SET PRINT FORMAT" – "MIN. WEIGHT OFF"

*	+0.01532 g	Minimum original weight has not been reached yet
	+0.07874 g	Minimum original weight has been reached

• "SET PRINT FORMAT" – "MIN. WEIGHT ON"

Min.Wgt. : 0.07500 g Actual : * + 0.01532 g	<i>Minimum original weight has not been reached yet</i>
Min.Wgt. : 0.07500 g Actual : + 0.07874 g	<i>Minimum original weight has been reached</i>

16.4.2 Displaying additional information with the function key «MIN...»

Normal display ("INFO LINE OFF", "ZERO KEY OFF"):

+ 0.00000 g MIN=0.07500	<i>Minimum original weight</i>
----------------------------	--------------------------------

Working sequence if «MIN = ...» (« \leftarrow ») is pressed (displayed for 2 seconds):

+ 0.00000 g ACT. TARE= 3.45136	<i>Current tare</i>
-----------------------------------	---------------------

then:

+ 0.00000 g MAX. TARE= 35.00000	<i>Maximum tare for which the displayed minimum original weight applies</i>
------------------------------------	---

16.4.3 Resetting with the function key «>0<»

Display in the event of "ZERO KEY ON":

+ 0.00000 g P MIN=0.07500 >0<	<i>Resetting took place in an identical tare range to the previous one.</i>
----------------------------------	---

+ 0.00000 g P MIN<0.07500 >0<	<i>Resetting took place in a different tare range to the previous one. The minimum original weight in the new tare range would actually be smaller (<).</i>
----------------------------------	--

Printout:

Min. Wgt. : > 0.07500 g Actual : * 0.00000 g	<i>I.e. the logged minimum original weight is actually too large or the requisite minimum original weight would actually be smaller (see display above).</i>
---	--

• Using the resetting:

If you reset the balance display using the tare key «T», the balance automatically determines the tare range of the tare weight, which is placed on, and sets the minimum original weight in accordance with this range. If you now reset the display in a series of weighing procedures with identical or similar tare weights between weighing procedures and ensure that the same minimum original weight is set at all times, use the "ZERO KEY" «>0<» instead of the tare key.

16.5 Determining the minimum original weight periodically

The minimum original weight is dependent on the ambient conditions. Therefore, it must be determined on-site and must be reviewed periodically.

The following parameters influence the minimum original weight:

• Repeatability:

The repeatability is determined by the standard deviation of the balance on-site. It is determined by the ambient conditions, the nature of the goods being weighed and the balance settings.

• Tare weight

• Relative uncertainty (U):

The tolerable uncertainty is determined by the user or defined by standards.

■ 16 Minimum original weight ("MIN.-WEIGHT")

- **Extension factor (k)** (generally 2 or 3):

The extension factor determines the likelihood of occurrence. The factor is defined by the user or is defaulted.

The minimum original weight is calculated as follows:

$$\text{Min. Weight}[\text{MIN}] = \frac{\text{Extension factor}[k] \cdot \text{Standard deviation}[\text{StdD}]}{\text{Relative uncertainty}[U]}$$

Example of figures for the MSW in accordance with the USP:

If work is conducted in accordance with the USP (United States Pharmacopoeia), the following parameters are given:

- **Repeatability:**

Standard deviation if the same weight is placed on ten times.

- **Extension factor:**

k = 3

- **Rel. uncertainty:**

U = 0.1%

The repeatability of an XR125SM in the tare range between 0 and 35 g was determined as a standard deviation on site by placing a weight on ten times and measures 0.025 mg.

The minimum original weight is thus calculated as follows:

$$\text{Min. Weight}[\text{MIN}] = \frac{3 \cdot 0.025 \text{ mg}}{0.1\%} \cdot 100\% = 75 \text{ mg}$$

In compliance with USP24-NF19, the original weight on the XR125SM may not be less than a minimum of 75 mg.

Recommended procedure:

- Conduct the tests on-site and as close to the real situation as possible.
- Try to provide the best possible ambient conditions.
Ensure that these conditions do not deteriorate significantly afterwards in normal operation.
- First of all, configure the "FLOATINGDISPLAY" and "STABILITY" weighing modes (see chapter 16.3.2 "Non-variable menu settings").
- Define the due-date for the next check, "NEXT TEST", in accordance with your QM specifications.
- Define the extension factor and relative uncertainty in accordance with your QM specifications and describe this under "Test parameters". The test parameters are merely for information purposes.
- Determine the minimum original weight(s) for your balance as follows:

Determining repeatabilities / Defining tare ranges:

First of all, test the behavior of the balance in different tare ranges:

Divide the balance's weighing range into 10g intervals, for example, and measure the repeatability for each interval.

Draw a graph of the entire weighing range by plotting all the results, joining them together and working

out the mean:

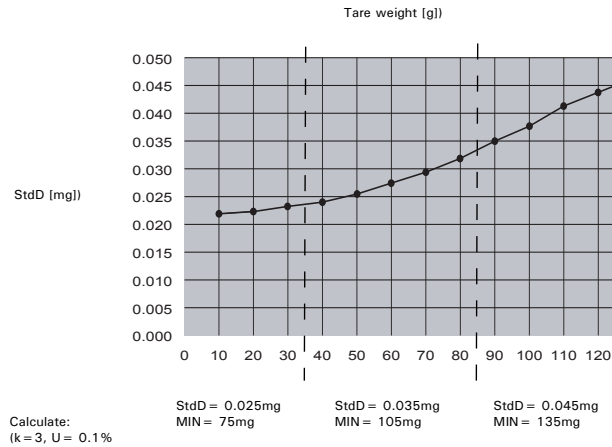

- On the basis of this graph it is relatively easy to define the max. 3 ranges with the corresponding repeatabilities. (If you know which tare weights are typically used, you can optimize the tare ranges in terms of these typical weights.)

Measuring the repeatability (StdD) with the aid of "STATISTIC": Apply the relevant tare weight permanently to the balance and tare it. Conduct the measurement series with a net weight of approx. 1g:

- 1: + 1.00287 g *Example of how the STATISTIC function is used.*
- 2: + 1.00291 g
-
- 9: + 1.00288 g
- 10: + 1.00290 g
- Values :
- Mean : + 1.00289 g
- StdE : + 0.000022 g
- StdE % : 0.00 %
- Max : + 1.00293 g
- Min : + 1.00287 g

- **Calculating the minimum original weight(s):**
Now calculate the minimum original weights using the equation shown above, on the basis of the repeatabilities belonging to the tare ranges.
- Configure the balance with the determined values.

■ 17 Dynamic weighing ("DYN.-WEIGHT")

17 Dynamic weighing ("DYN.-WEIGHT")

17.1 Introduction to the dynamic weighing application

The "DYN. WEIGHT" workflow supports accurate weighing on an unstable surface, e.g. on board ships. During the period of measurement defined by the user in the setup menu, the balance measures continuously, calculates the mean of the saved values at the end of the period of measurement and indicates the average measurement value which this yields.

17.2 Selecting the dynamic weighing application

In order to activate the application menu, press the «MENU» key and select the "DYN. WEIGHT" application.

• SELECT APPLICATION	
SET APP.OFF	<i>Normal weighing mode</i>
...	...
...	...
DYN. WEIGHT	<i>Dynamic weighing</i>
...	...
...	...

The submenus which are required for defining the dynamic weighing are now displayed in the "SETUP APPLICATION" menu.

17.3 Configuring dynamic weighing

In the setup, specify the period of measurement over which the mean is to be calculated.

• SETUP APPLICATION		
DYN. WEIGHT	MEASURETIME	4 <i>Enter the period of time in seconds</i>

17.4 Dynamic weighing

Press «C» briefly to go to dynamic weighing.

<div style="border: 1px solid black; padding: 5px; display: inline-block;"> <p style="text-align: center; margin: 0;">67,8907 9</p> <p style="margin: 0;">MAN AUTO TARE STO</p> </div>	<i>Display during dynamic weighing</i>
--	--

Configuration of the function keys:

Key	Functions
«MAN»	Manual activation of the measurement.
«AUTO»	Automatic activation of the measurement with a 1-second delay.
«TARE»	Determine the tare over the period of measurement and save it for other measurements.
«STO»	Statistics and storage function if statistics are activated.

18 Pipette calibration ("PIPETTE")

18.1 Introduction to pipette calibration

Quality management systems require volumetric measuring equipment to be checked regularly. This application allows you to check pipettes of any make by means of a gravimetric method.

You require a thermometer and a barometer in order to conduct this.

During the pipette test, the sample volume is always derived from the sample weight. The density of the test liquid (distilled water) and the buoyancy are taken into account during conversion.

The pipette application supports up to 20 pipettes. By simply selecting the pipette you require, its specifications are loaded into the application. You can then commence the pipette test straight away.

The pipette specification data must be defined once beforehand in accordance with the manufacturer's details. You can change this at any time later on.

If you wish to adjust the pipette, please consult the pipette manufacturer's instructions.

18.2 Selecting the pipette calibration application

In order to activate pipette calibration, press the «MENU» key and select the "PIPETTE" application.

• SELECT APPLICATION		
SET APP.	OFF	Normal weighing mode

	PIPETTE	Pipette calibration

18.3 Configuring the pipette calibration

In the "SETUP APPLICATION" menu, specify the measuring sequence and define the pipettes. The tolerances for inaccuracy and imprecision are manufacturer and model-specific. Refer to the pipette manufacturer's documentation for data.

• SETUP APPLICATION				
PIPETTE	SAMPLES	10		
	EVAPORATION MEAS.	ON/OFF		
	SET PIPETTES	PIPETTE- 1	NAME ttt...	
			SNO. ttt...	
			VOL.1	VOLUME 0.00000 ml INACCUR. <E> 0.0 % IMPREC. <STDE> 0.0 % CYCLE TIME 0.0 s
			VOL.2	ditto
			VOL.3	ditto
		PIPETTE- 2	NAME ttt...	
			SNO. ttt...	
			VOL.1	VOLUME 0.00000 ml INACCUR. <E> 0.0 % IMPREC. <STDE> 0.0 % CYCLE TIME 0.0 s
			VOL.2	ditto
			VOL.3	ditto
	
		PIPETTE-20	ditto	ditto

English

■ 18 Pipette calibration ("PIPETTE")

"SAMPLES"

Enter the number of random sample measurements per volume (setting range: 2-50).

"EVAPORATION MEAS."

- ON: The evaporation over the cycle time is automatically determined before the pipetting process starts, after the tare vessel is placed on, and the pipetting volumes are thus corrected accordingly.
- OFF: The evaporation rate is not taken into account.

"SET PIPETTES"

Select one of the 20 pipettes.

"NAME"

Enter a description for the selected pipette (max. 20 characters).

"SNO."

Enter a serial number for the selected pipette (max. 20 characters).

If a barcode marking on the pipette is used as the serial number, the pipette can be selected directly by reading in the barcode during the pipette test.

"VOL. 1, 2, 3"

Up to three test volumes can be selected per pipette. Pipettes with a variable volume are normally tested at 10%, 50% and 100% of the maximum volume.

"VOLUME"

Enter the test volume in [ml].

"INACCUR. <E>"

The permissible incorrectness is entered for each volume in terms of [%] of the test volume. The incorrectness describes the systematic error (setting range: (+/-) 0.1 - 9.9%).

"IMPREC. <STDE>"

The permissible imprecision (standard deviation) is entered for each volume in terms of [%] of the test volume. The imprecision describes the statistical error (setting range: 0.1 - 9.9%).

CYCLE TIME



The cycle time determines the duration of a single measurement (suck in liquid, discharge, wait for a stable weighing reading). The weighing reading is adopted at the end of the cycle time. This facilitates reproducible work. Short cycle times minimize evaporation losses; large volumes require longer cycle times (slow discharge of the pipette volume) (setting range: 0-120s).

18.4 Working with the pipette

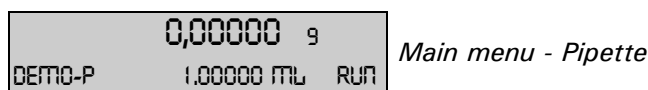
The user can switch between weighing mode and pipette calibration by pressing the «» key.



Configuration of the function keys:

Key	Functions
«DEMO-P»	Pipette selection (can also be selected by means of a barcode reader)
«1.00000 mL»	Select the test volume ("VOL.1" is the default) (select with «  » and «  », confirm with «  »)
«RUN»	Start the program (see chapter 18.4.1 "Conducting the pipette test")

18.4.1 Conducting the pipette test

Press «esc» to stop the procedure at any time.

Display	Key	Step
	«←»	If necessary, change the (starting) temperature
	«←»	If necessary, change the air pressure
	«↓»	Place the container with the liquid receiver (distilled water) on the balance
<p>The balance is tared automatically. The evaporation measurement then starts if it is activated in the setup; otherwise, the first sample measurement starts.</p>		
		Evaporation measurement running
	«↑» or «↓»	Evaporation measurement ends. Press «OK» to confirm the measurement or «REP» to repeat it, where necessary.

Note:

This must result in a **reduction** in weight! If the reading does not seem plausible, you should repeat the evaporation measurement.

The actual **pipette measurement** starts now:

Display	Key	Step
		The balance is tared automatically.
		As soon as 0.00000g appears on the display, the 1st random sample can be pipetted in.
	«↑» or «↓»	1st random sample measurement ended. Press «OK» to confirm the measurement or «REP» to repeat it, where necessary.
		The balance is tared automatically.
		As soon as 0.00000g appears on the display, the 2nd random sample can be pipetted in.
<p>Perform the process for all n random samples. Rejected samples are not counted; their number is logged.</p>		
	«↑» or «↓»	nth random sample measurement ended. Press «OK» to confirm the measurement or «REP» to repeat it, where necessary.
	«←»	If necessary, change the (end) temperature

The result of the pipette test is displayed in the last step:

Display	Key	Step
	«↑» or «↓»	Pipette test passed.

■ 18 Pipette calibration ("PIPETTE")

Display	Key	Step
<div style="border: 1px solid black; padding: 5px;"> <p style="text-align: right;">0,00000 9</p> <p>FAILED INF END</p> </div>	«↑» or «↓»	<i>Pipette test failed.</i>

Press the «**PRINT**» key to print out the report on the pipette test or to send it to the PC.

Press «**INF**» («↑») to display the results on the balance display as well:

Display	Key	Step
<div style="border: 1px solid black; padding: 5px;"> <p style="text-align: right;">0,00000 9</p> <p>MEAN 0.99823 mL</p> </div>	«↑»	<i>Average</i>
<div style="border: 1px solid black; padding: 5px;"> <p style="text-align: right;">0,00000 9</p> <p>E. 0.00177 mL</p> </div>	«↑»	<i>Incorrectness</i>
<div style="border: 1px solid black; padding: 5px;"> <p style="text-align: right;">0,00000 9</p> <p>E-% - 0.18 %</p> </div>	«↑»	<i>Incorrectness [%]</i>
<div style="border: 1px solid black; padding: 5px;"> <p style="text-align: right;">0,00000 9</p> <p>STDE. 0.00057 mL</p> </div>	«↑»	<i>Imprecision as a standard deviation</i>
<div style="border: 1px solid black; padding: 5px;"> <p style="text-align: right;">0,00000 9</p> <p>STDE-% 0.06 %</p> </div>	«↑»	<i>Imprecision as a relative standard deviation [%]</i>
<div style="border: 1px solid black; padding: 5px;"> <p style="text-align: right;">0,00000 9</p> <p>MAX. 0.99884 mL</p> </div>	«↑»	<i>Maximum volume</i>
<div style="border: 1px solid black; padding: 5px;"> <p style="text-align: right;">0,00000 9</p> <p>MIN. 0.99767 mL</p> </div>	«↑»	<i>Minimum volume</i>
<div style="border: 1px solid black; padding: 5px;"> <p style="text-align: right;">0,00000 9</p> <p>1= 0.99782 mL</p> </div>	«↑»	<i>1st measurement reading</i>
<div style="border: 1px solid black; padding: 5px;"> <p style="text-align: right;">0,00000 9</p> <p>_ = mL</p> </div>	«↑»	<i>all the other measurement readings follow</i>
<div style="border: 1px solid black; padding: 5px;"> <p style="text-align: right;">0,00000 9</p> <p>PASSED INF END</p> </div>	«↑» or «↓»	

Press «**END**» to exit the measurement series. WARNING: the values are not saved in the balance.

18.4.2 Report

```
----- PIPETTE-CHECK -----  
  
Date 28.07.2004 Time 10:03:16  
Name      : XR 125 SM  
Software  : V00-0000 P00  
Serienr   : 2601-26  
  
Pipetten-Name : DEMO-PIPETTE  
Serie-Nr.    : 7610700607077  
Test Volume  : 1.00000 ml  
Inaccuracy (E) : 0.5 %  
Impprecision(StdE) : 0.2 %  
Cycle Time   : 15 s  
  
Temp. 1 :      22.0 C  
Temp. 2 :      23.0 C  
Air Pr.  :      1013.0 hPa  
Evapor.  : - 0.00016 ml  
  
Mean     : + 0.99823 ml  
E        : - 0.00177 ml  
E %      : - 0.18 %  
StdE.    : + 0.00057 ml  
StdE. %  : + 0.06 %  
  
Max      : + 0.99884 ml  
Min      : + 0.99767 ml  
Values   :      10  
Reject.  :      0  
  
  1 : + 0.99782 ml  
  2 : + 0.99859 ml  
  ...  
  9 : + 0.99767 ml  
 10 : + 0.99884 ml  
  
User :  
  
-----
```

■ 19 Air buoyancy correction ("BEST")

19 Air buoyancy correction ("BEST")

19.1 Introduction to air buoyancy correction

The "BEST" (*Buoyancy Error Suppression Technology*) application can be used to correct errors which arise as a result of air buoyancy.

Balances are adjusted with steel weights with a density of 8 g/cm³ to prevent errors occurring at this density.

As soon as goods of other densities are weighed, the air buoyancy causes an error which can be corrected by the factor K.

$$K = \frac{1 - \frac{\rho(\text{air})}{\rho(\text{steel})}}{1 - \frac{\rho(\text{air})}{\rho_{\text{material}}}}$$

ρ air:
Density of air in kg/m³

ρ material:
Density of the material being weighed in kg/m³

ρ steel:
constant 8000 kg/m³

This correction is automatically conducted in the "BEST" application once the air and material density has been entered.

19.2 Selecting the air buoyancy correction application

In order to activate the application menu, press the «MENU» key and select the "BEST" application.

• SELECT APPLICATION		
SET APP.	OFF	Normal weighing mode

	BEST	BEST (Buoyancy Error Suppression Technology)

19.3 Configuring the air buoyancy correction

The "SETUP APPLICATION" menu now contains the settings for the air buoyancy correction.

• SETUP APPLICATION			
BEST	AIR DENSITY	1.200000	Air density in kg/m ³ (0.9-1.5 kg/m ³)
	MAT. DENSITY	8.000000	Material density in g/cm ³ (0.1-1.25 g/ccm)

19.4 Working with the air buoyancy correction

Press «» briefly to go to the air buoyancy correction.

When the air buoyancy correction starts, the user is prompted to confirm the air density.

1,200000	<i>Current air density in kg/m³</i>
OK SET	

Configuration of the function keys:

Key	Functions
«OK»	Accept or confirm the current air density
«SET»	Enter a new value for the current air density

19.4.1 Weighing weights

Once you have accepted the current air density by pressing «OK», the balance can be used as in normal weighing mode, i.e. taring with «T» etc., for example.

For marking purposes, the weight display contains the weight reading, which has been offset against the air buoyancy correction; preferred readings are also marked with a small circle ("o"). This circle is included in the printout. The value of the material density, which is used for the correction, is specified in the info line.







```

o +      1,94683  9
8.000000 9.CCM
  
```



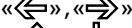

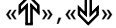

Current weight, "air buoyancy-corrected"

19.4.2 Changing the air density

Press «» briefly twice to confirm the air density.

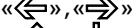
Display	Key	Step
<pre> 1,200000 OK SET </pre>	«  »	Switch to enter the new air density
<pre> ----- AIR DENSITY 1.200000 </pre>	«  »	Start the air density entry
<pre> ----- AIR DENSITY 1.198000 </pre>	«  », «  » «  », «  »	Enter the new air density
<pre> ----- AIR DENSITY 1.198000 </pre>	«  »	Confirm the entry
<pre> 1,198000 OK SET </pre>	«esc»	Go back to the air density confirmation

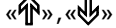
19.4.3 Changing the material density

Display	Key	Step
<pre> o + 1,94683 9 8.000000 9.CCM </pre>	«  »	Switch to enter the new material density
<pre> ----- MAT. DENSITY 8.000000 </pre>	«  »	Start entering the new material density
<pre> ----- MAT. DENSITY 8.123456 </pre>	«  », «  » «  », «  »	Enter the new material density
<pre> ----- MAT. DENSITY 8.123456 </pre>	«  »	Confirm the entry
<pre> o + 1,94683 9 8.123456 9.CCM </pre>	«esc»	Go back to weighing with air buoyancy correction

20 User profiles (MUM, Multiuser Memory)

10 different user profiles can be saved. They can be protected against changes by means of a personal 4-digit password. A profile consists of the configuration and application settings.

Anyone who does not wish to create a personal user profile can work with the balance as a "guest". The settings from the last user profile used are applied. If a "guest" works with the balance, device options and settings can be changed, although they are not saved when the balance is switched off.

• SET USER		
USER	ttt...	User name
NEW PASSWORD	----	Enter user password
CLEAR USER		Clear active user

20.1 Activating a user

- Press «ON/OFF» to switch on the balance.
- Hold down «C» constantly during the start-up process (approx. 10 seconds) until „NEW USER“ appears in the display.
- A new user can be selected by pressing the «←» key. The balance completes start-up and switches to Weighing mode.

20.2 Creating a new user profile

If no user profile has yet been defined, the balance can be used normally. In order to work with different user configurations, Work with Users must first be activated.

Display	Key	Step
+ 0,00000 9	«MENU»	Start the application menu.
----- SET APP. OFF	«↑»	Press repeatedly, until „SET USER“ is displayed.
----- SET USER	«⇒»	Switch into the user identification menu options.
----- USER	«←»	Activate the user name entry and enter the required name using the cursor keys. A user name may be up to 20 characters long.
----- USER EXAMPLE	«←»	Confirm the entry.
----- NEW PASSWORD ----	«↓»	If you wish, protect the user settings with a four-digit password.
----- NEW PASSWORD 0 0 0 0	«←»	The first digit of the password flashes and can be changed.
----- NEW PASSWORD 8 0 0 0	«↑» «↓»	Press until the first digit in the password is set.
----- NEW PASSWORD 8 0 0 0	«⇒»	The second digit flashes. The password can now be entered fully.
----- NEW PASSWORD 8 2 3 5	«←»	Confirm the password.

The user is defined. Press «esc» to exit the menu.

If there is a password set, it must be entered before making changes in the configuration and application menus.

! NOTE
<p>Make a note of your personal password.</p> <p>If a user loses his password, he can be enabled again using the password 7 9 1 4.</p> <p>This password is the same for all balances and is always valid in parallel to the password which the user has selected.</p>

20.3 Changing the password and password protection

- The password can be entered by entering a new password.
- Password protection can be disabled by resetting the current password to **0 0 0 0**.

20.4 Clearing a user

A user can be cleared by selecting the „CLEAR USER“ option in the menu and pressing «↵» to confirm this entry.

If no further users are defined, Work with Users must be activated again in order to facilitate work with users.

Display	Key	Step
<div style="border: 1px solid black; padding: 5px; background-color: #f0f0f0;"> <p style="text-align: center;">-----</p> <p>CLEAR USER</p> </div>	«↓»	Select the „CLEAR USER“ menu option.
<div style="border: 1px solid black; padding: 5px; background-color: #f0f0f0;"> <p style="text-align: center;">-----</p> <p>SET USER</p> </div>	«↵»	The active user is cleared.

20.5 Setting the user

When the balance is started up, the system asks for the desired user profile.

Display	Key	Step
<div style="border: 1px solid black; padding: 5px; background-color: #f0f0f0;"> <p style="text-align: center;">-----</p> <p>USER EXAMPLE</p> </div>	«↑» «↓»	Select the desired user profile and press the «↵» key to confirm.

- If one of the defined user profiles is selected, the corresponding user password must be entered, where necessary. The user can then work with the balance.
- If „USER GUEST“ is selected, any available settings can be defined, although they are not saved.
- If „USER NEW“ is selected, the user name and the password must be entered in the application menu in order to define the user profile.

■ 21 Data transfer

21 Data transfer

For data-transfers to peripheral devices, the balance is equipped with an RS232/V24-interface.

Before the data-transfer, the RS232 interface must be matched with the one in the peripheral device in the balance configuration menu (see chapter 10.3.6 "Interface functions").

- **Handshake**

The handshake is set to „NO“ (none) at the factory. It can be set to software handshake „XON-XOFF“, or to hardware handshake „HARDWARE“.

- **Baud rate**

Possible baud rates: 300, 600, 1200, 2400, 4800, 9600, 19200, 38400, 57600 baud.

- **Parity**

Possible parity: 7 even 1 stop, 7 odd 1 stop, 7 no 2 stop, 8 no 1 stop, 8 even 1 stop, 8 odd 1 stop.

Pos.	0	1	2	3	4	5	6	7	8	9	10
7-even-1	SB	1.DA	2.DA	3.DA	4.DA	5.DA	6.DA	7.DA	PB	SP	-
7-odd-1	SB	1.DA	2.DA	3.DA	4.DA	5.DA	6.DA	7.DA	PB	SP	-
7-no-2	SB	1.DA	2.DA	3.DA	4.DA	5.DA	6.DA	7.DA	1.SP	2.SP	-
8-no-1	SB	1.DA	2.DA	3.DA	4.DA	5.DA	6.DA	7.DA	8.DA	SP	-
8-even-1	SB	1.DA	2.DA	3.DA	4.DA	5.DA	6.DA	7.DA	8.DA	PB	SP
8-odd-1	SB	1.DA	2.DA	3.DA	4.DA	5.DA	6.DA	7.DA	8.DA	PB	SP

SB: Start bit PB: Parity bit

DA: Data bit SP: Stop bit

- **Display**

S	D7	D6	D5	D4	D3	D2	D1	D0	U	U	U
---	----	----	----	----	----	----	----	----	---	---	---

The data-transfer takes place in ASCII code:

1	2	3	4	5	6	7	8	9	10	11	12	13	14	15
B	B	B	S	D7	D6	D5	D4	D3	D2	D1	DP	D0	B	U	...	CR	LF

B Blank (space)

S Sign (+, -, space)

DP Decimal point

D0...D7 Digits

U ... Unit (only if the weight is stable, otherwise no unit is sent)

CR Carriage return

LF Line feed



NOTE

Unused positions are filled with spaces. The decimal point DP can be between D0 and D7.

If the value format is user defined, the format is not as mentioned above!

21.1 Connection scheme

- **Standard duplex connection**

Balance	DB 9 female	D25 / D9	Peripheral device
RS 232 out	2	3 / 2	RS 232 in
RS 232 in	3	2 / 3	RS 232 out
GND	5	7 / 5	GND

- Standard, duplex connection with additional hardware handshake in the peripheral device

Balance	DB 9 female	D25 / D9	Peripheral device
RS 232 out	2 →	3 / 2	RS 232 in
RS 232 in	3 ←	2 / 3	RS 232 out
GND	5	7 / 5	GND
CTS	4 ←	20 / 4	DTR
DTR	8 →	5 / 8	CTS

21.2 Remote control-commands

Command	Function
ACKn	Acknowledge n=0 off; n = 1 on
CAL	Start calibration
D.....	Describe weight display (right-aligned)
DN	Reset weight display
@.....	Describe Info display
@N	Reset Info display
In	Set FLOATINGDISPLAY time nn = 0 t = 0.04 s n = 1 t = 0.08 s n = 2 t = 0.16 s n = 3 t = 0.32 s
N	Reset balance
OFF	Switch off balance
ON	Switch on balance
PCxxxx	Enter anti-theft code
PDT	Print out date and time
PRT	Start printing (Press « PRINT » key)
PST	Start print status
Pn (ttt.t)	Set print mode n = 0 Individually print each value (unstable) n = 1 Individually print each value (stable) n = 2 Print after change of load n = 3 Print after each integration period n = 4 Print on time basis in s (ttt.t)
R%k	Set current weight = 100% with k=0...7 decimal places (k=A: use automatic positioning of decimal point)
REF%k rrr	Set reference weight rrr for 100% with k=0...7 decimal places (k=A: use automatic positioning of decimal point)
Rnnn	Set current weight = nnn items
REFrrr	Set reference weight rrr for 1 item
Sn	Set stability n n = 0 low n = 1 medium n = 2 high
SDTttmmjj hhmmss	Set date and time (German) (Tag, Monat, Jahr, Stunde, Minute, Sekunde)
SDTmmddy hhmmss	Set date and time (English) (Month, Day, Year, Hour, Minutes, Seconds)
T (ttt)	Tare or set tare to a specific value
Uxnn	Set unit x (1...4) of the balance with nn (0 = g, 1 = mg, 2 = kg, ...)
UxS	Switch balance to unit x (1...4)
ZERO	Zero balance (provided weight is stable and within the zero position range)

■ 21 Data transfer



NOTE

Each remote control-command must terminate with «CR» «LF». The commands are acknowledged if required.

21.2.1 Examples for the remote control

Input	Description of the function executed
D - - - - -	Five dashes are displayed
DTEST123	tESt123 is displayed
D	The display is dark
T100	-100.000 g (Tare set to 100 g)
T1	-1.000 g (Tare set to 1g)
T	Balance is tared

22 Maintenance and servicing

22.1 Calibration

The calibration of the balance is fixed in the Configuration menu (see chapter 9.7 "Calibration of the balance" and see chapter 10.3.4 "Calibration functions").

Possible types of calibration, depending on the model of balance:

- External calibration by means of ICM (Intelligent Calibration Mode)
- External calibration with freely selectable weight
- Internal calibration
- Automatic calibration

! NOTE

The calibration can be interrupted at any time by pressing «ON/OFF».

22.1.1 External calibration by means of ICM

Depending on the type of balance, calibration weights in steps of 10 g, 50 g, 100 g and 500 g can be used, where the calibration weight must correspond to the precision of the balance.

For an external calibration by means of ICM, „SET CALIBRATION MODE EXTERNAL“ must be selected in the Configuration menu (see chapter 10.3.4 "Calibration functions").

Display	Key	Step
		<i>The balance is in Weighing mode.</i>
	«T»	<i>Press until „CALIBRATION“ appears.</i>
		<i>The balance carries out a Zero measurement „0000 g“ is shown flashing).</i>
		<i>After the zero measurement the display flashes with the recommended calibration weight.</i>
		<i>Place the calibration weight on the weighing pan. The display continues to flash.</i>
		<i>Calibration is complete when the display stops flashing</i>

22.1.2 External calibration with freely selectable weight

For external calibration with user-definable weight, „SET CALIBRATION MODE EXT. -DEF.“ must be selected in the Configuration menu (see chapter 10.3.4 "Calibration functions").

Then, the effective value of the calibration weight (DEF. n.nnn g) must be entered with up to tenfold precision compared with the balance.

! NOTE

If calibration is carried out with the free weight, then only this weight may be used.

■ 22 Maintenance and servicing

Then proceed as follows:

Display	Key	Step
		<i>The balance is in Weighing mode.</i>
	«T»	<i>Press until „CALIBRATION“ appears.</i>
		<i>The balance carries out a Zero measurement „0000 g“ is shown flashing).</i>
		<i>After the zero measurement the display flashes with the previously entered calibration weight.</i>
		<i>Place the calibration weight. The display continuous to flash.</i>
		<i>Calibration is complete when the display stops flashing</i>

22.1.3 Internal calibration

For internal calibration with the built-in calibration weight „SET CALIBRATION MODE INTERNAL“ must be selected in the Configuration menu (see chapter 10.3.4 "Calibration functions").

Then proceed as follows:

- Switch to „WEIGHING“ with the Change key
- Press «T» until „CALIBRATION“ is shown.
- Calibration is finished after a certain period of time

22.1.4 Automatic calibration

For automatic calibration with the built-in calibration weight „SET CALIBRATION MODE AUTO“ must be selected in the Configuration menu (see chapter 10.3.4 "Calibration functions").

The balance now calibrates itself automatically every 24 hours and/or after each temperature change of 3 degrees Celsius, depending on the definition in the Configuration menu „SET CALIBRATION MODE AUTO“.

The time of the automatic calibration is as determined in the Configuration menu under „SET CALIBRATION AUTOCAL. -TIME n h“. (e.g. 6 h for 06.00 o'clock in the morning)

! NOTE

For automatic calibration by time and by time/temp. the date and time of the balance must first be correctly set (see chapter 10.3.7 "Date and time.").

Calibration can also be effected manually at any time when auto-calibration is activated.

Automatic calibration then takes place only if no weight has been placed on the pan for at least five minutes.

It is recommended that the time for auto-calibration be set outside the normal business hours (for example, in the early morning).

22.2 Automatic Repeatability Test (ART)

During the Automatic Repeatability Test, the internal weight is measured 10 times, and the standard deviation is calculated from this and logged.

Display	Key	Step
		<i>The balance is in Weighing mode.</i>

Display	Key	Step
	«T»	Press until „REPEATABILITY TEST“ appears.
		The internal weight is applied and measured. 10 measurements are performed.
	«↓»	If required, the measuring program can be exited.
		The standard deviation of the measurement is calculated and displayed as a result, and the log is printed.

22.3 Software update

Our balances are instruments which are being continuously advanced and improved. For this reason, it is possible to update to the latest version of the instrument software via the internet.

In order to update your software, you need to download the Download Tool from the website and install it onto a PC with Windows.

The software for the balance can also be downloaded from the Downloads area on the website. This can then be loaded into the instrument with the aid of the download tool.

22.4 Cleaning

The balance must be treated carefully and cleaned regularly. It is a precision instrument.

DANGER

For maintenance work, the balance must be separated from the power supply (remove power adaptor plug from socket). Also ensure that the balance cannot be reconnected to the power supply during the work by a third party.

Take care during cleaning that no liquid penetrates into the appliance. If liquid is spilt on the balance, the latter must immediately be disconnected from the electricity supply. The balance must only be used again after it has first been checked by a Service Engineer.

The connections on the rear of the appliance and the power adaptor must not come into contact with liquids.

Regularly dismantle the weighing pan and the weighing pan holder and remove any dirt or dust from under the weighing pan and on the balance housing with a soft brush or a soft, lint-free cloth, moistened with a mild soap solution.

The weighing pan and the holder can be cleaned under running water. Take care that both parts are completely dry before they are re-installed on the balance.

CAUTION

Never use solvents, acids, alkalis, paint thinners, scouring powders or other aggressive or corrosive chemicals for cleaning, since these substances attack the surfaces of the balance housing and can cause damage.

The regular maintenance of the balance by your Service Representative will guarantee unlimited function and reliability over many years and will extend the lifespan of the balance.

22.5 Error messages

The balance shows a description of the fault in the info-line.

! NOTE

If an error occurs without a description of the error in the info-line, the Customer Service must be called.

22.5.1 Notes on correcting faults

The following table shows faults and their possible causes. If you cannot clear the fault using the table, please contact the Customer Service..

Fault	Possible cause
Weight display does not light	<ul style="list-style-type: none"> • Balance not switched on • Connection to power adaptor is interrupted • Power supply has failed (interruption to current) • The power adaptor is defective
"OL" is shown in display	<ul style="list-style-type: none"> • The weight range has been exceeded (Observe information on the maximum weight range)
"UL" is shown in display	<ul style="list-style-type: none"> • The weight range is below the range of the balance (Scale pan or scale pan holder missing)
The weight display fluctuates continuously	<ul style="list-style-type: none"> • The draft is too strong at the balance location • The balance support is vibrating or varying • The scale pan is touching a foreign body • The time chosen for FLOATINGDISPLAY is too short • The material being weighed is absorbing moisture • The material being weighed is being blown away or is evaporating • Strong temperature variations in the material being weighed
Results of weighing are clearly incorrect	<ul style="list-style-type: none"> • The balance was not correctly tared • The balance is not correctly levelled • The calibration is no longer correct • There are strong temperature variations
There is no display or only dashes	<ul style="list-style-type: none"> • The stability control (Balance functions) is set too sensitively • The time selected for „FLOATINGDISPLAY“ is unsatisfactory
Configuration menu cannot be changed	<ul style="list-style-type: none"> • The password lock is activated in the configuration menu
The display flashes continuously during calibration	<ul style="list-style-type: none"> • The balance location is not stable enough (Interrupt calibration with «ON/OFF» and relocate the balance in a better position) • Use of an imprecise calibration weight (only applies to external calibration)

23 Menu trees

23.1 Configuration menu tree

• UNIT-1	
UNIT-1	g mg kg ... Bht
• SET DATA PRINT	
	AUTOSTART ON/OFF
	MODE UNSTABLE STABLE LOADCHANGE CONTINUOUS TIMEBASE
	TIMEBASE 2.0
	SET PRINTFORMAT
	DATE AND TIME ON/OFF BALANCE-ID ON/OFF PRODUCT-ID ON/OFF GROSS AND TARE ON/OFF UNITS ON/OFF USER ON/OFF LINEFEED OFF/1/2/.../9/FORMFEED
	PRODUCT tt...
	PRODUCTMODE HOLD DELETE COUNT
• SET CALIBRATION	
	MODE OFF EXTERNAL EXT.-DEF. INTERNAL AUTO
	DEF. 0.000 g
	AUTOCAL. TIME/TEMP. TEMPERATURE TIME
	AUTOCAL.-TIME 6 h
• SET WEIGHING MODE	
	FLOATINGDISPLAY 0.08 0.16 0.32
	STABILITY LOW MEDIUM HIGH
	AUTO-STANDBY OFF 0.5 MIN 1 MIN 5 MIN 10 MIN
	AUTO-ZERO ON/OFF
	QUICK-TARE ON/OFF

■ 23 Menu trees

• SET INTERFACE	
	BAUDRATE 300 600 1200 2400 4800 9600 19200 38400 57600
	PARITY 7-EVEN-1STOP 7-ODD-1STOP 7-NO-2STOP 8-NO-1STOP 8-EVEN-1STOP 8-ODD-1STOP
	HANDSHAKE NO XON-XOFF HARDWARE
	PC DIRECT MODE OFF/ON
• SET DATE AND TIME	
	TIME [HH.MM.SS]
	DATE [DD.MM.YY]
	FORMAT STANDARD/US
• THEFTCODE	
THEFTCODE ----	THEFT-PROTECTION OFF/ON
	NEW CODE - - - -
• KEY TONE	
KEY TONE	ON/OFF
• BUS	
BUS	ON/OFF
• LANGUAGE	
	LANGUAGE ENGLISH SPRACHE DEUTSCH LANGUE FRANCAISE
• BACKLIGHT	
BACKLIGHT	6

23.2 Application menu tree

• SET APP.	
	OFF
	UNITS
	COUNT
	PERCENT
	CALCULATOR
	PAPER
	NET-TOTAL
	SUM
	ANIMAL
	etc.

Other applications available, siehe Kap. 11 "Application".

• SETUP APPLICATION	

Division depends on the current application, siehe Kap. 11 "Application".

• SET STATISTICS	

MODE	OFF
	STATISTICS
	RECORDER
	STAT./RECORDER
COUNT	100
RECORDING	MANUAL
	TIMEBASE
	LOADCHANGE
TMEBASE	2.0

• SET CHECK +/-	

MODE	ON/OFF
NOM.	100.000 g
TO	120.000 g
TU	80.000 g

• AUTO-START	
AUTO-START	ON/OFF

• SET USER	

USER	ttt...
NEW PASSWORD	----
CLEAR USER	